

OMNI-2155

Expandable HMI Panel PC

User's Manual 2nd Ed

Copyright Notice

This document is copyrighted, 2015. All rights are reserved. The original manufacturer reserves the right to make improvements to the products described in this manual at any time without notice.

No part of this manual may be reproduced, copied, translated, or transmitted in any form or by any means without the prior written permission of the original manufacturer. Information provided in this manual is intended to be accurate and reliable. However, the original manufacturer assumes no responsibility for its use, or for any infringements upon the rights of third parties that may result from its use.

The material in this document is for product information only and is subject to change without notice. While reasonable efforts have been made in the preparation of this document to assure its accuracy, someone assumes no liabilities resulting from errors or omissions in this document, or from the use of the information contained herein.

Acknowledgement

All other products' name or trademarks are properties of their respective owners.

- AMD[®] is trademark of Advanced Micro Devices.
- Microsoft Windows[®] is a registered trademark of Microsoft Corp.
- ITE is a trademark of Integrated Technology Express, Inc.
- IBM, PC/AT, PS/2, and VGA are trademarks of International Business Machines Corporation.

All other product names or trademarks are properties of their respective owners.

Packing List

Before setting up your product, please make sure the following items have been shipped:

Item	Quantity
● OMNI-2155	1
● Phoenix power connector	1
● Product CD with User's Manual (in pdf) and drivers	1

If any of these items are missing or damaged, please contact your distributor or sales representative immediately.

About this Document

This User's Manual contains all the essential information, such as detailed descriptions and explanations on the product's hardware and software features (if any), its specifications, dimensions, jumper/connector settings/definitions, and driver installation instructions (if any), to facilitate users in setting up their product.

Users must refer to the latest version of this document.

Safety Precautions

Please read the following safety instructions carefully. It is advised that you keep this manual for future references

1. All cautions and warnings on the device should be noted.
2. Make sure the power source matches the power rating of the device.
3. Position the power cord so that people cannot step on it. Do not place anything over the power cord.
4. Always completely disconnect the power before working on the system's hardware.
5. No connections should be made when the system is powered as a sudden rush of power may damage sensitive electronic components.
6. If the device is not to be used for a long time, disconnect it from the power supply to avoid damage by transient over-voltage.
7. Always disconnect this device from any AC supply before cleaning.
8. While cleaning, use a damp cloth instead of liquid or spray detergents.
9. Make sure the device is installed near a power outlet and is easily accessible.
10. Keep this device away from humidity.
11. Place the device on a solid surface during installation to prevent falls
12. Do not cover the openings on the device to ensure optimal heat dissipation.
13. Watch out for high temperatures when the system is running.
14. Do not touch the heat sink or heat spreader when the system is running
15. Never pour any liquid into the openings. This could cause fire or electric shock.
16. As most electronic components are sensitive to static electrical charge, be sure to ground yourself to prevent static charge when installing the internal components. Use a grounding wrist strap and contain all electronic components in any static-shielded containers.

17. If any of the following situations arises, please the contact our service personnel:
 - i. Damaged power cord or plug
 - ii. Liquid intrusion to the device
 - iii. Exposure to moisture
 - iv. Device is not working as expected or in a manner as described in this manual
 - v. The device is dropped or damaged
 - vi. Any obvious signs of damage displayed on the device
18. **DO NOT LEAVE THIS DEVICE IN AN UNCONTROLLED ENVIRONMENT WHERE THE STORAGE TEMPERATURE IS BELOW -20° C (-4°F) OR ABOVE 70°C (158°F) TO PREVENT DAMAGE.**

Warning!



This device complies with Part 15 FCC Rules. Operation is subject to the following two conditions: (1) this device may not cause harmful interference, and (2) this device must accept any interference received including interference that may cause undesired operation.

Caution:

There is a danger of explosion if the battery is incorrectly replaced. Replace only with the same or equivalent type recommended by the manufacturer. Dispose of used batteries according to the manufacturer's instructions and your local government's recycling or disposal directives.

Attention:

Il y a un risque d'explosion si la batterie est remplacée de façon incorrecte. Ne la remplacer qu'avec le même modèle ou équivalent recommandé par le constructeur. Recycler les batteries usées en accord avec les instructions du fabricant et les directives gouvernementales de recyclage.

China RoHS Requirements (CN)

产品中有毒有害物质或元素名称及含量

AAEON Panel PC/ Workstation

部件名称	有毒有害物质或元素					
	铅 (Pb)	汞 (Hg)	镉 (Cd)	六价铬 (Cr(VI))	多溴联苯 (PBB)	多溴二苯醚 (PBDE)
印刷电路板 及其电子组件	×	○	○	○	○	○
外部信号 连接器及线材	×	○	○	○	○	○
外壳	×	○	○	○	○	○
中央处理器 与内存	×	○	○	○	○	○
硬盘	×	○	○	○	○	○
液晶模块	×	○	○	○	○	○
光驱	×	○	○	○	○	○
触控模块	×	○	○	○	○	○
电源	×	○	○	○	○	○

O: 表示该有毒有害物质在该部件所有均质材料中的含量均在
SJ/T 11363-2006 标准规定的限量要求以下。

X: 表示该有毒有害物质至少在该部件的某一均质材料中的含量超出
SJ/T 11363-2006 标准规定的限量要求。

备注:

- 一、此产品所标示之环保使用期限，系指在一般正常使用状况下。
- 二、上述部件物质中央处理器、内存、硬盘、光驱、触控模块为选购品。

China RoHS Requirement (EN)

Poisonous or Hazardous Substances or Elements in Products
 AAEON Panel PC/ Workstation

Component	Poisonous or Hazardous Substances or Elements					
	Lead (Pb)	Mercury (Hg)	Cadmium (Cd)	Hexavalent Chromium (Cr(VI))	Polybrominated Biphenyls (PBB)	Polybrominated Diphenyl Ethers (PBDE)
PCB & Other Components	X	○	○	○	○	○
Wires & Connectors for External Connections	X	○	○	○	○	○
Chassis	X	○	○	○	○	○
CPU & RAM	X	○	○	○	○	○
Hard Disk	X	○	○	○	○	○
LCD	X	○	○	○	○	○
Optical Drive	X	○	○	○	○	○
Touchscreen	X	○	○	○	○	○
PSU	X	○	○	○	○	○
<p>O: The quantity of poisonous or hazardous substances or elements found in each of the component's parts is below the SJ/T 11363-2006-stipulated requirement.</p> <p>X: The quantity of poisonous or hazardous substances or elements found in at least one of the component's parts is beyond the SJ/T 11363-2006-stipulated requirement.</p> <p>Note: The Environment Friendly Use Period as labeled on this product is applicable under normal usage only</p>						

Table of Contents

- Chapter 1 - Product Specifications..... 1**
 - 1.1 Specifications..... 2
 - 1.2 OMNI Modules 6
 - 1.2.1 USB/ COM/ LAN Module 6
 - 1.2.2 Dual LAN Module..... 6
 - 1.2.3 MiniCard and SIM Card Module..... 7
 - 1.2.4 RS-232/422/485 Module 7
 - 1.2.5 Isolated RS-232/422/485 Module..... 8
 - 1.2.6 Digital I/O Module..... 8
 - 1.2.7 CAN Bus Module 8
 - 1.2.8 Audio Module 9
- Chapter 2 – Hardware Information10**
 - 2.1 Dimensions 11
 - 2.2 List of Jumpers 14
 - 2.2.1 Clear CMOS (JP1) 15
 - 2.2.2 AT/ATX Mode Selection (JP3)..... 15
 - 2.2.3 LVDS Port Backlight Lightness Control Mode Selection (JP4) ... 15
 - 2.2.4 LVDS Inverter Voltage Selection (JP5) 15
 - 2.2.5 LVDS Inverter Voltage Selection (JP6) 16
 - 2.2.6 Touch Selection (JP8) 16
 - 2.2.7 COM2 +12V/+5V/Ring Selection (JP9)..... 16
 - 2.3 List of Connectors 17
 - 2.3.1 MiniCard Connector with On-board SIM (CN3) 18
 - 2.3.2 LPC Debug Port (CN4) 19
 - 2.3.3 Battery Connector (CN6) 19
 - 2.3.4 Cfast Connector (CN10)..... 20

2.3.5	Board to Board Connector (CN11)	21
2.3.6	LVDS Backlight Connector (CN17)	22
2.3.7	Mini PCIe Slot (CN18)	23
2.3.8	SATA Power Connector (CN19)	25
2.3.9	SATA Connector (CN20)	25
2.3.10	LVDS Connector (CN21)	25
2.3.11	HDMI Connector (CN22)	26
2.3.12	Touchscreen Connector (CN29)	27
2.3.13	LAN1 Connector (CN37)	28
2.3.14	LAN2 Connector (CN38)	28
2.3.15	DC-in (CN39)	29
2.3.16	COM2 Connector (CN40)	29
2.3.17	Remote Switch Connector (CN43)	30
2.4	Assembling Modules	31
2.5	Installing the Hard Disk Drive	32
2.6	Installing DRAM	33
2.7	Installing the Panel Mount Kit	34
Chapter 3	- AMI BIOS Setup	35
3.1	System Test and Initialization	36
3.2	AMI BIOS Setup	37
3.3	Setup Submenu: Main	38
3.4	Setup Submenu: Advanced	39
3.4.1	Advanced: CPU Configuration	40
3.4.2	Advanced: IDE Configuration	41
3.4.3	Advanced: USB Configuration	42
3.4.4	Advanced: Hardware Monitor	43
3.4.5	Advanced: Power Management	44
3.4.6	Advanced: Super IO Management	45

3.4.6.1	Super IO Management: Serial Port 1 Configuration.....	46
3.4.6.2	Super IO Management: Serial Port 2 Configuration.....	47
3.4.6.3	Super IO Management: Serial Port 3 Configuration.....	48
3.4.6.4	Super IO Management: Serial Port 4 Configuration.....	49
3.4.6.5	Super IO Management: Serial Port 5 Configuration.....	50
3.4.6.6	Super IO Management: Serial Port 6 Configuration (Optional)	51
3.4.6.7	Super IO Management: Serial Port 7 Configuration (Optional)	52
3.4.6.8	Super IO Management: Serial Port 8 Configuration (Optional)	53
3.5	Setup submenu: Chipset.....	54
3.5.1	Chipset: North Bridge.....	55
3.5.1.1	North Bridge: Display Control Configuration	56
3.5.2	Chipset: South Bridge.....	59
3.6	Setup submenu: Security	60
3.7	Setup submenu: Boot.....	61
3.8	Boot: BBS Priorities.....	62
3.9	Setup submenu: Exit.....	63
Chapter 4	– Drivers Installation & Touchscreen Settings	64
4.1	Product CD/DVD.....	65
4.2	PCAP Dual Monitor Touch Settings.....	73
Appendix A	- Watchdog Timer Programming.....	75
A.1	Watchdog Timer Initial Program.....	76
Appendix B	- I/O Information.....	78
B.1	I/O Address Map.....	79
B.2	Memory Address Map.....	81
B.3	IRQ Mapping Chart	82

Chapter 1

Product Specifications

1.1 Specifications

System

- **Processor**
 - Intel® Celeron® J1900, 2 GHz
 - Intel® Atom™ N2807, 1.58 GHz
- **System Memory**
 - 204-pin DDR3L 1333 MHz SODIMM x 1, up to 8 GB, (J1900)
 - 204-pin DDR3L 1333 MHz SODIMM x 1, up to 4 GB, (N2807)
- **Ethernet**
 - 10/100/1000Base-TX, RJ-45 x 2
- **Side I/O**
 - USB 3.0 Type A x 1
 - USB 2.0 Type A x 3
 - SMA antenna hole x 1
 - HDMI x 1
 - CFast x 1
- **Bottom I/O**
 - DB-9 for RS-485/422/232 x 1
 - 10/100/1000Base-T, RJ-45 x 2
 - DB-15 for VGA x 1
 - 3-pin terminal block for 9~30 Vdc power input x 1
 - LED Power on/off switch x1
 - (Power on = orange, Power off = N/A)
- **Storage Disk Drive**
 - CFast socket x 1 (Easy-to-Swap)
 - Internal SATA 2.5" HDD x 1
- **Expansion Slot**
 - Mini PCIe x 2
 - OMNI expansion slot
- **OS Support**
 - Windows® 8

Windows® 7

Windows Embedded Standard 7

Linux kernel 2.6.x or above

Mechanical

- **Construction** IP65/ NEMA 4 for aluminum front bezel
IP30 ECC chassis
- **Mounting** VESA100
- **Dimension (W x H x D)** 420 x 265 x 60 mm (16.5 x 10.4 x 2.4")
- **Carton Dimension (W x H x D)** 530 x 445 x 200 mm (20.9 x 17.5 x 7.9")
- **Gross Weight** 3 kg (6.6 lb)

Environmental

- **Operating Temperature** -20°C~60°C with industrial grade device (with 0.5 m/s air flow, according to IEC68-2-14, CPU: N2807)
-20°C~55°C with industrial grade device (with 0.5 m/s air flow, according to IEC68-2-14, CPU: J1900)

***Users should use wide temperature DRAM and wide temperature storage devices if OMNI-2155 is operating above 40°C.**

- **Storage Temperature** -20 ~ 70°C (-4 ~ -158°F)
- **Operating Humidity** 90% @ 40°C, non-condensing

- **Anti-Vibration** 1 Grms/ 5 ~ 500 Hz/ Operation (HDD)
- **Anti-Shock** 15 G peak acceleration (11 msec. duration)
- **EMC** CE/FCC Class A

Power Supply

- DC Input 9 ~ 30 V

LCD

- Display Type 15.6" TFT LCD, LED
- Max. Resolution 1366 x 768
- Max Colors 16.7M colors (6/8-bit for R, G, B)
- Luminance (cd/m²)5 400 nits
- Viewing Angle 170° (H), 160° (V)
- Backlight LED
- Backlight MTBF (Hours) 50,000

Touchscreen

- Type P-CAP / 5-Wireless resistive
- Light Transmission 90 ±3% / 80% ± 5%
- Lifetime 100,000,000 keystrokes

1.2 OMNI Modules

Featuring a modular designed, the OMNI-2155 can be fitted with a number of modules to expand its base capabilities. Please refer to the sections below for their features.

1.2.1 USB/ COM/ LAN Module

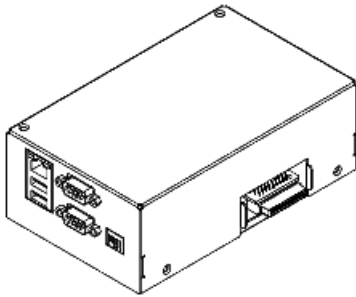

Features

- USB 2.0 x 2
- RS-232/422/485 x 2 (Selectable by external switch)
- Giga LAN x 1

1.2.2 Dual LAN Module

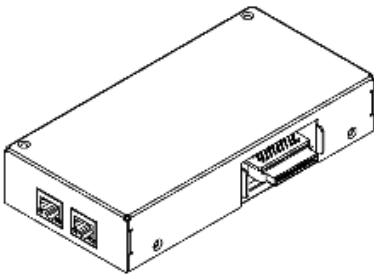

Features

- Giga LAN x 2

1.2.3 MiniCard and SIM Card Module

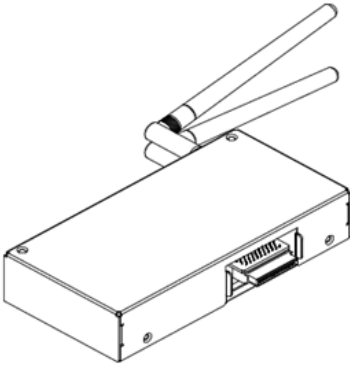

Features

- MiniCard x 2
- SIM Card x 2

1.2.4 RS-232/422/485 Module

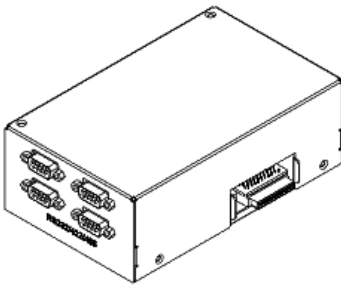

Features

- RS-232/422/485 x 4
(Selectable by jumper)

1.2.5 Isolated RS-232/422/485 Module

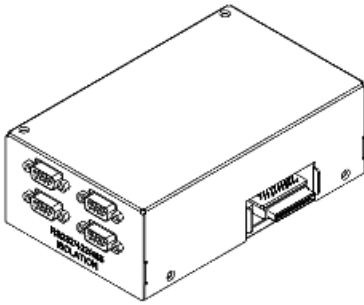

Features

- Isolated RS-232/422/485 x 4
(Selectable by jumper)
- 2k Vdc Isolation

1.2.6 Digital I/O Module

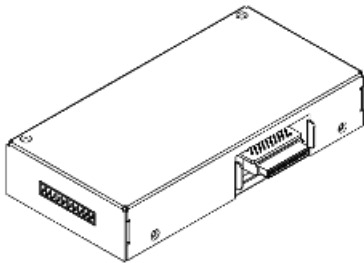

Features

- Digital I/O x 8

1.2.7 CAN Bus Module

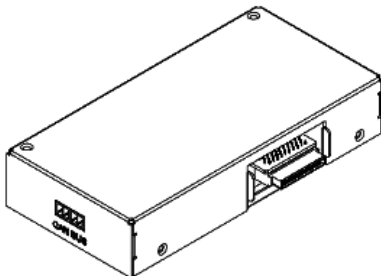

Features

- CAN Bus with Phoenix connectors
- 2k Vdc Isolation

1.2.8 Audio Module

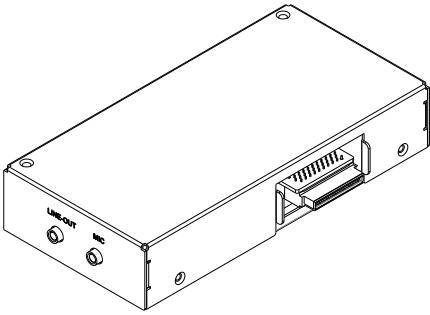

Features

- Mic-in
- Line-out

Chapter 2

Hardware Information

2.1 Dimensions

Main Panel

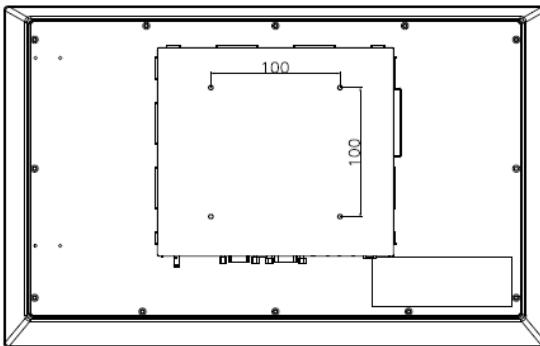
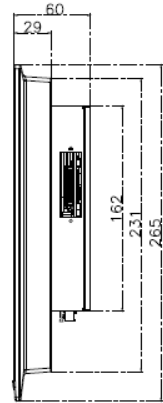
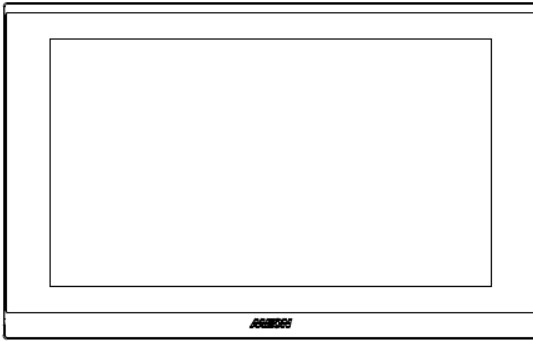
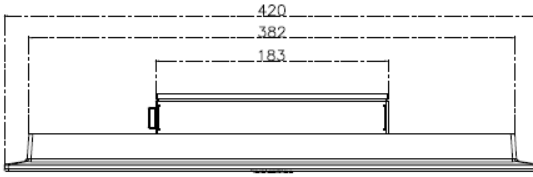

OMNI Modules

USB/ CAN/ LAN Module

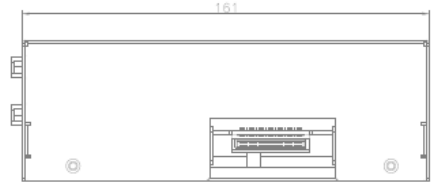
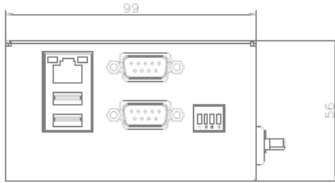

Dual LAN Module

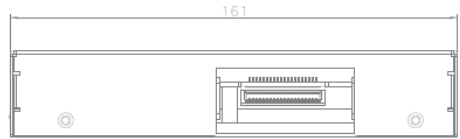
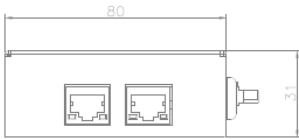

MiniCard & SIM Card Module

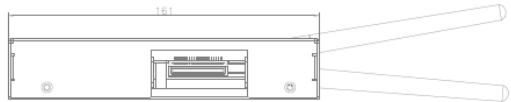

RS-232/422/485 Module

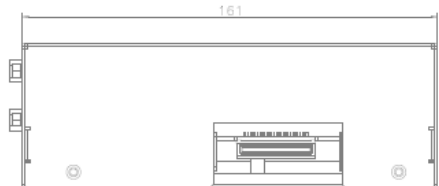
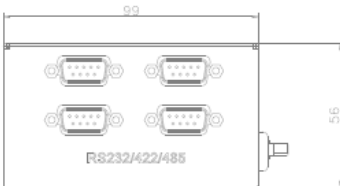

Isolated RS-232/422/485 Module

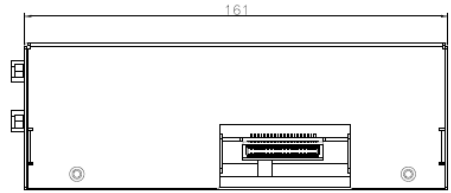
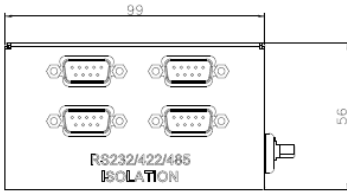

Digital I/O Module

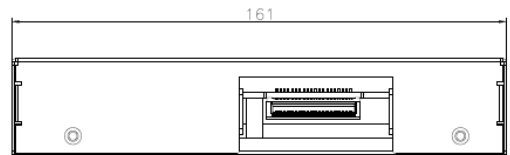
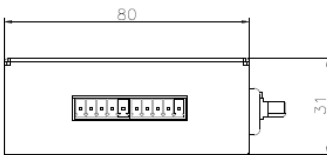

CAN Bus Module

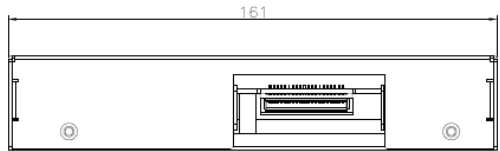
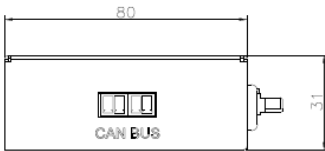

Audio Module

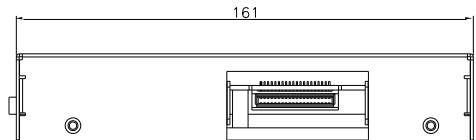
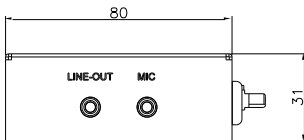

2.2 List of Jumpers

Please refer to the table below for all of the board's jumpers that you can configure for your application

Label	Function
JP1	Clear CMOS
JP3	AT/ATX mode selection
JP4	LVDS Port Backlight Lightness Control Mode Selection
JP5	LVDS inverter Voltage Selection
JP6	LVDS Voltage Selection
JP7	COM3 +12V/+5V/RING Selection
JP8	Touch Selection

2.2.1 Clear CMOS (JP1)

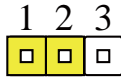

Normal (Default)

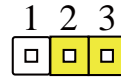

Clear CMOS

2.2.2 AT/ATX Mode Selection (JP3)

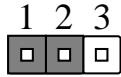

Disable (Default)

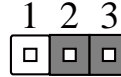

Enable

2.2.3 LVDS Port Backlight Lightness Control Mode Selection (JP4)

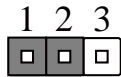

VR Mode

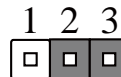

PWM Mode (Default)

2.2.4 LVDS Inverter Voltage Selection (JP5)

Pin	Function
1-2	+12 V (Default)
2-3	+5 V

2.2.5 LVDS Inverter Voltage Selection (JP6)

Pin	Function
1-2	+12 V (Default)
2-3	+5 V

2.2.6 Touch Selection (JP8)

Pin	Function
1-2	4, 8 wire
2-3	5 wire (Default)

2.2.7 COM2 +12V/+5V/Ring Selection (JP9)

Pin	Function
1-2	+12 V
3-4	Ring (Default)
5-6	+5 V

2.3 List of Connectors

Please refer to the table below for all of the board's connectors that you can configure for your application

Label	Function
CN3	MiniCard Connector with on-board SIM
CN4	LPC debug port
CN6	Battery connector
CN9	SIM socket
CN10	CFast connector
CN11	Board to board connector
CN17	LVDS backlight connector
CN18	Mini PCIe slot (mSATA select)
CN19	SATA power connector (+5V)
CN20	SATA connector
CN21	LVDS connector
CN22	HDMI connector
CN28	Dual stack USB connector(3.0/2.0)
CN29	Touchscreen connector
CN30	SPI Connector
CN32	Dual stack USB connector(2.0)
CN37	LAN1 connector
CN38	LAN2 connector
CN39	DC-IN
CN40	COM2 connector
CN41	VGA connector
CN43	Remote switch connector

2.3.1 MiniCard Connector with On-board SIM (CN3)

Pin	Signal	Pin	Signal
1	PCIE_WAKE#	2	+V3.3A
3	NC	4	GND
5	NC	6	+1.5V
7	PCIE_CLK_REQ#	8	UIM_PWR
9	GND	10	UIM_DATA
11	PCIE_REF_CLK-	12	UIM_CLK
13	PCIE_REF_CLK+	14	UIM_RST
15	GND	16	UIM_VPP
17	NC	18	GND
19	NC	20	W_DISABLE#
21	GND	22	PCIE_RST#
23	PCIE_RX-	24	+V3.3A
25	PCIE_RX+	26	GND
27	GND	28	+1.5V
29	GND	30	SMB_CLK
31	PCIE_TX-	32	SMB_DATA
33	PCIE_TX+	34	GND
35	GND	36	USB_D-
37	GND	38	USB_D+
39	+V3.3A	40	GND
41	+V3.3A	42	NC
43	GND	44	NC
45	NC	46	NC
47	NC	48	+1.5V
49	NC	50	GND

51

NC

52

+V3.3A

2.3.2 LPC Debug Port (CN4)

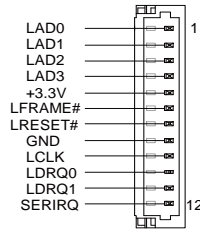

Pin	Pin Name	Signal Type	Signal Level
1	LAD0	I/O	+3.3V
2	LAD1	I/O	+3.3V
3	LAD2	I/O	+3.3V
4	LAD3	I/O	+3.3V
5	+3.3V	PWR	+3.3V
6	LFRAME#	IN	
7	LRESET#	OUT	+3.3V
8	GND	GND	
9	LCLK	OUT	
10	LDRQ0	IN	
11	LDRQ1	IN	
12	SERIRQ	I/O	+3.3V

2.3.3 Battery Connector (CN6)

Pin	Signal
1	RTC

2.3.4 Cfast Connector (CN10)

Pin	Pin Name	Signal Type	Signal Level
S1	GND	GND	
S2	SATA_TX+	DIFF	
S3	SATA_TX-	DIFF	
S4	GND	GND	
S5	SATA_RX-	DIFF	
S6	SATA_RX+	DIFF	
S7	GND	GND	
PC1	NC		
PC2	GND	GND	
PC3	NC		
PC4	NC		
PC5	NC		
PC6	NC		
PC7	GND	GND	
PC8	NC		
PC9	NC		
PC10	NC		
PC11	NC		
PC12	NC		
PC13	+3.3V	PWR	+3.3V
PC14	+3.3V	PWR	+3.3V
PC15	GND	GND	
PC16	GND	GND	

2.3.5 Board to Board Connector (CN11)

Pin	Pin Name	Signal Type	Signal Level
1	+V5A	PWR	+5V
2	+V5A	PWR	+5V
3	+V5A	PWR	+5V
4	+V5A	PWR	+5V
5	+V3.3A	PWR	+3.3V
6	+V3.3A	PWR	+3.3V
7	+V3.3A	PWR	+3.3V
8	EX_PLT_RST#	out	
9	+V12S	PWR	+12V
10	W_DISABLE0#	out	
11	CLK_LPC_25M_EXT	out	
12	LPC_FRAME#	out	
13	INT_SERIRQ_3P3	out	
14	LPC_AD3	out	
15	LPC_AD2	out	
16	LPC_AD1	out	
17	LPC_AD0	out	
18	Wake#	out	
19	SMBUS_DATA	BI	
20	USB_DN2	DIFF	
21	SMBUS_CLK	BI	
22	USB_DP2	DIFF	
23	GND	GND	

24	GND	GND
25	P2_REFCLKN	DIFF
26	P2_RXN	DIFF
27	P2_REFCLKP	DIFF
28	P2_RXP	DIFF
29	GND	GND
30	GND	GND
31	P2_TXN	DIFF
32	CLK_PCIE_EXIO_N	DIFF
33	P2_TXP	DIFF
34	CLK_PCIE_EXIO_P	DIFF
35	GND	GND
36	GND	GND
37	PCIE_RXN3	DIFF
38	PCIE_TXN3	DIFF
39	PCIE_RXP3	DIFF
40	PCIE_TXP3	DIFF

2.3.6 LVDS Backlight Connector (CN17)

Pin	Signal	Pin	Signal
1	VDD	2	BKL_CTL
3	GND	4	GND
5	BKL_EN		

2.3.7 Mini PCIe Slot (CN18)

Pin	Pin Name	Signal Type	Signal Level
1	PCIE_WAKE#	IN	
2	+3.3VSB	PWR	+3.3V
3	NC		
4	GND	GND	
5	NC		
6	+1.5V	PWR	+1.5V
7	PCIE_CLK_REQ#	IN	
8	NC	PWR	
9	GND	GND	
10	NC	I/O	
11	PCIE_REF_CLK-	DIFF	
12	NC	IN	
13	PCIE_REF_CLK+	DIFF	
14	NC		
15	GND	GND	
16	NC	PWR	
17	NC		
18	GND	GND	
19	NC		
20	W_DISABLE#	OUT	+3.3V
21	GND	GND	
22	PCIE_RST#	OUT	+3.3V
23	PCIE_RX-/MSATA_RX+	DIFF	
24	+3.3VSB	PWR	+3.3V
25	PCIE_RX+/MSATA_RX-	DIFF	

26	GND	GND	
27	GND	GND	
28	+1.5V	PWR	+1.5V
29	GND	GND	
30	SMB_CLK	I/O	+3.3V
31	PCIE_TX-/MSATA_TX-	DIFF	
32	SMB_DATA	I/O	+3.3V
33	PCIE_TX+/MSATA_TX+	DIFF	
34	GND	GND	
35	GND	GND	
36	USB_D-	DIFF	
37	GND	GND	
38	USB_D+	DIFF	
39	+3.3VSB	PWR	+3.3V
40	GND	GND	
41	+3.3VSB	PWR	+3.3V
42	NC		
43	GND	GND	
44	NC		
45	NC		
46	NC		
47	NC		
48	+1.5V	PWR	+1.5V
49	NC		
50	GND	GND	
51	NC		
52	+3.3VSB	PWR	+3.3V

2.3.8 SATA Power Connector (CN19)

Pin	Signal
1	+ V5S
2	GND

2.3.9 SATA Connector (CN20)

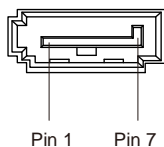

Pin	Pin Name	Signal Type	Signal Level
1	GND	GND	
2	SATA_TX+	DIFF	
3	SATA_TX-	DIFF	
4	GND	GND	
5	SATA_RX-	DIFF	
6	SATA_RX+	DIFF	
7	GND	GND	

2.3.10 LVDS Connector (CN21)

Pin	Signal	Pin	Signal
1	BKL_EN	2	BKL_CTL
3	NA	4	GND
5	NA	6	+V1.5S

7	NA	8	UIM_PWR2
9	GND	10	UIM_DAT2
11	REFCLK-	12	UIM_CLK2
13	REFCLK+	14	UIM_RST2
15	LVDSA_DATA3#	16	UIM_VPP2
17	LVDS_DDC_DATA	18	LVDS_DDC_CLK
19	LVDSB_DATA0#	20	LVDSB_DATA0
21	LVDSB_DATA1#	22	LVDSB_DATA1
23	LVDSB_DATA2#	24	LVDSB_DATA2
25	LVDSB_DATA3#	26	LVDSB_DATA3
27	LVDSVCC	28	GND
29	LVDSB_CLK#	30	LVDSB_CLK

2.3.11 HDMI Connector (CN22)

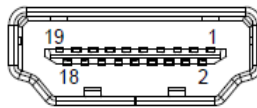

Pin	Pin Name	Signal Type	Signal Level
1	TMDS_DAT2+	DIFF	
2	GND	GND	
3	TMDS_DAT2-	DIFF	
4	TMDS_DAT1+	DIFF	
5	GND		
6	TMDS_DAT1-	DIFF	
7	TMDS_DAT0+	DIFF	
8	GND	GND	
9	TMDS_DAT0-	DIFF	
10	TMDS_CLK+	DIFF	

11	GND	DIFF	
12	TMDS_CLK-	DIFF	
13	NC		
14	NC		
15	DDC_CLK	I/O	+5V
16	DDC_DATA	I/O	+5V
17	GND	GND	
18	+5V	PWR	+5V
19	HPLG_DETECT	IN	

2.3.12 Touchscreen Connector (CN29)

8 Wires

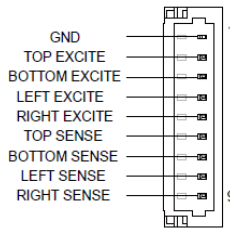

Pin	Signal	Pin	Signal
1	GND	2	TOP EXCITE
3	BOTTOM EXCITE	4	LEFT EXCITE
5	RIGHT EXCITE	6	TOP SENSE
7	BOTTOM SENSE	8	LEFT SENSE
9	RIGHT SENSE		

2.3.13 LAN1 Connector (CN37)

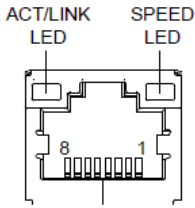

Pin	Signal	Pin	Signal
1	MDI0+	2	MDI0-
3	MDI1+	4	MDI2+
5	MDI2-	6	MDI1-
7	MDI3+	8	MDI3-

2.3.14 LAN2 Connector (CN38)

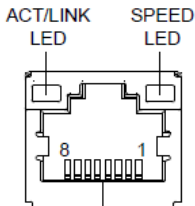

Pin	Signal	Pin	Signal
1	MDI0+	2	MDI0-
3	MDI1+	4	MDI2+
5	MDI2-	6	MDI1-
7	MDI3+	8	MDI3-

2.3.15 DC-in (CN39)

Pin	Signal	Pin	Signal
1	9-30V	2	GND
3	EARTH_GND		

2.3.16 COM2 Connector (CN40)

RS-232			
Pin	Signal	Pin	Signal
1	DCD	2	RXD
3	TXD	4	DTR
5	GND	6	DSR
7	RTS	8	CTS
9	RI		

RS-422			
Pin	Signal	Pin	Signal
1	TXD-	2	TXD+
3	RXD+	4	RXD-
5	GND	6	N/C
7	N/C	8	N/C
9	N/C		

RS-485			
Pin	Signal	Pin	Signal
1	D-	2	D+

3	N/C	4	N/C
5	GND	6	N/C
7	N/C	8	N/C
9	N/C		

2.3.17 Remote Switch Connector (CN43)

Pin	Signal	Pin	Signal
1	EXT_PWRBTN#	2	GND

2.4 Assembling Modules

To install a module, insert the connector to the OMNI slot by the side of the PCB box as shown in the image below and secure with the screws provided.

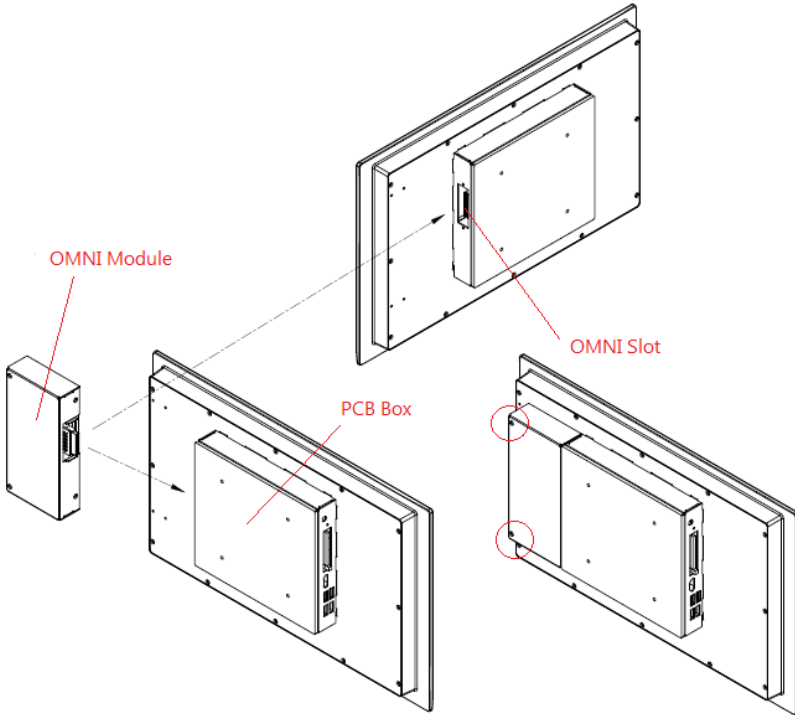

2.5 Installing the Hard Disk Drive

1. Place the HDD onto the bracket and secure with the screws provided

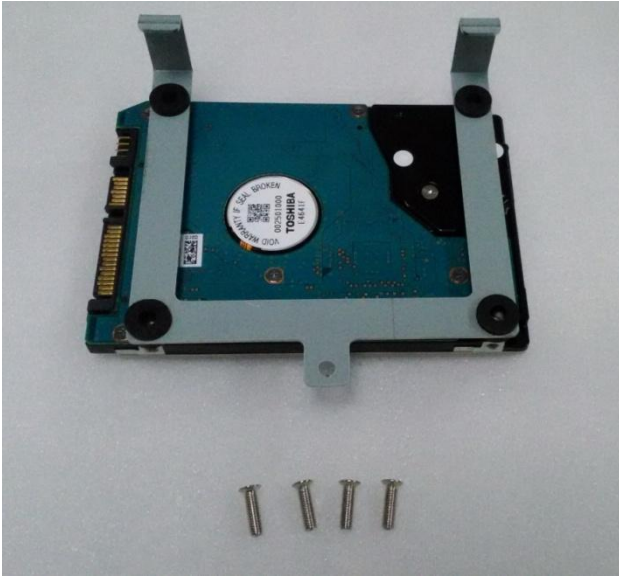

2. Hook the setup on to the bar above the PCB board as shown below. Secure it with the screw provided

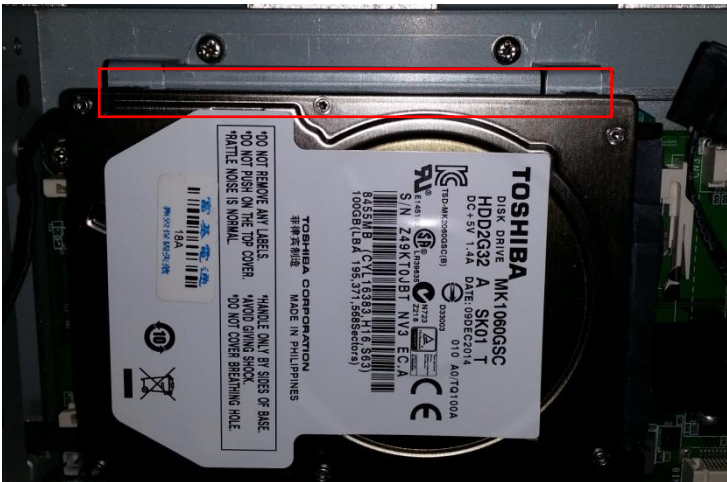

* Users are advised to use storage devices provided and installed by AEON.

2.6 Installing DRAM

To install DRAM, remove the HDD and HDD bracket and insert the RAM module as shown below.

* Users are advised to use DRAM modules provided and installed by AAEON.

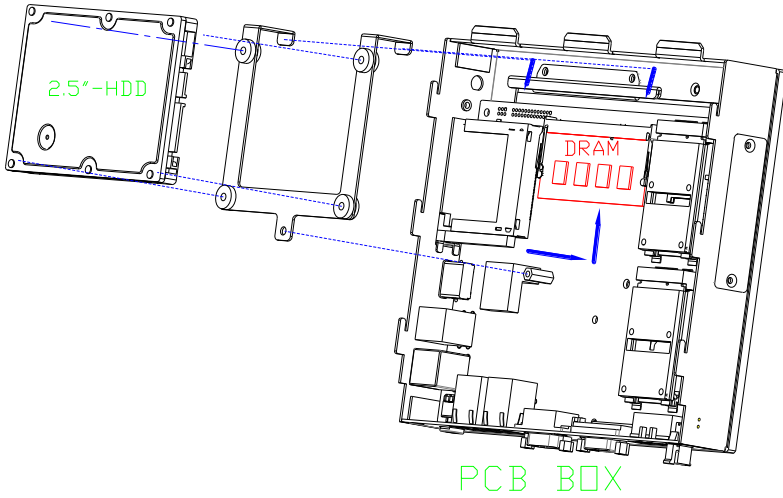

2.7 Installing the Panel Mount Kit

Screw the kit on to the panel as shown below with the screws provided. It is advised to assemble the module before the installing the kit.

Note: Due to the size of the **isolated RS-232/422/485, RS-232/422/485, and USB/COM/ LAN modules**, the leftmost panel mount kit will be not be installable. However, the panel can still be mounted with the remaining panel mount kits.

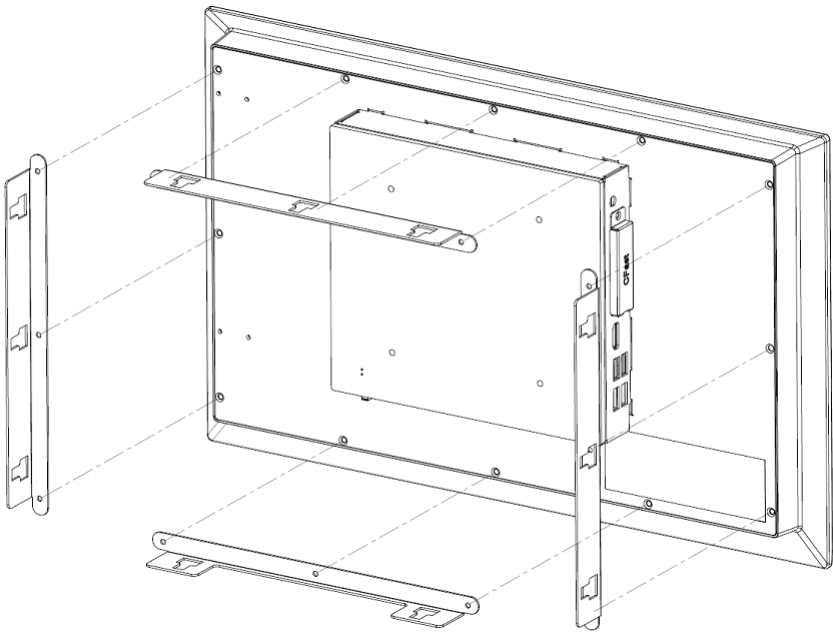

Chapter 3

AMI BIOS Setup

3.1 System Test and Initialization

The board uses certain routines to perform testing and initialization. If an error, fatal or non-fatal, is encountered, a few short beeps or an error message will be outputted. The board can usually continue the boot up sequence with non-fatal errors.

The system configuration verification routines check the current system configuration against the values stored in the CMOS memory. If they do not match, an error message will be outputted, in which case you will need to run the BIOS setup program to set the configuration information in memory.

There are three situations in which you will need to change the CMOS settings:

- You are starting your system for the first time
- You have changed your system's hardware
- The CMOS memory has lost power and the configuration information is erased

The system's CMOS memory uses a backup battery for data retention, which is to be replaced once emptied.

3.2 AMI BIOS Setup

The AMI BIOS ROM has a pre-installed Setup program that allows users to modify basic system configurations, which is stored in the battery-backed CMOS RAM and BIOS NVRAM so that the information is retained when the power is turned off.

To enter BIOS Setup, press or <F2> immediately while your computer is powering up.

The function for each interface can be found below.

Main – Date and time can be set here. Press <Tab> to switch between date elements

Advanced – Enable/ Disable boot option for legacy network devices

Chipset – For hosting bridge parameters

Boot – Enable/ Disable quiet Boot Option

Security – The setup administrator password can be set here

Save & Exit – Save your changes and exit the program

3.3 Setup Submenu: Main

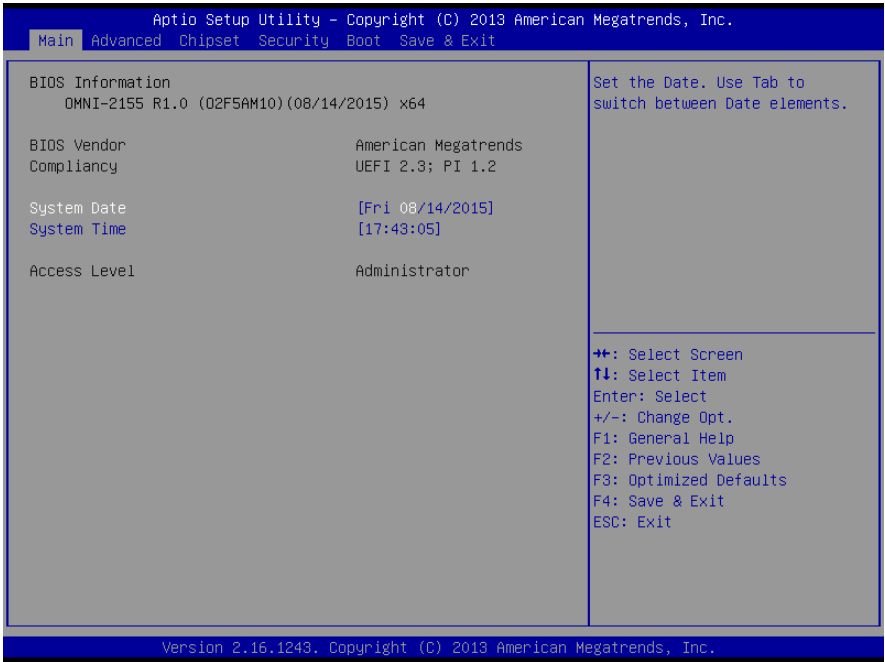

3.4 Setup Submenu: Advanced

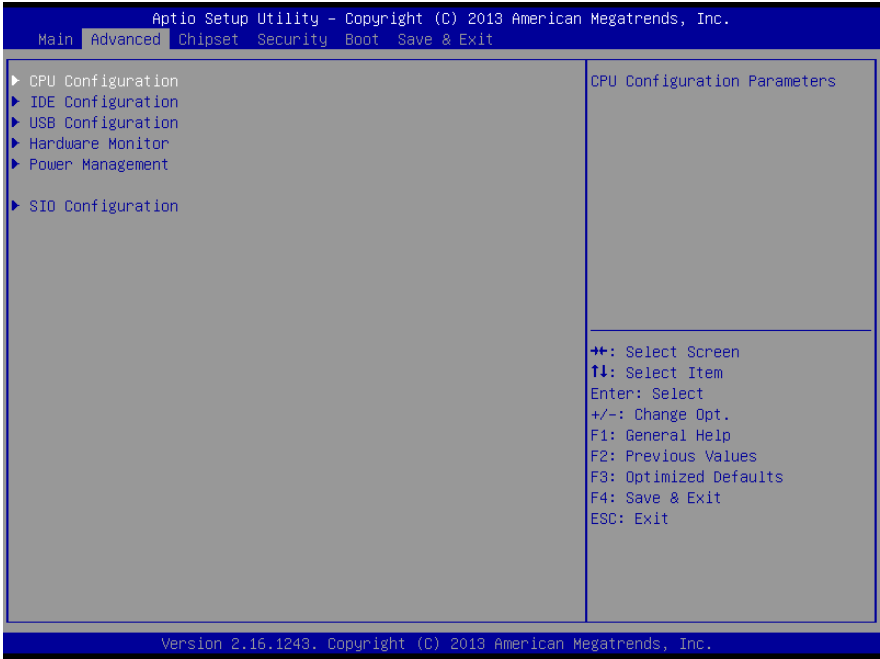

3.4.1 Advanced: CPU Configuration

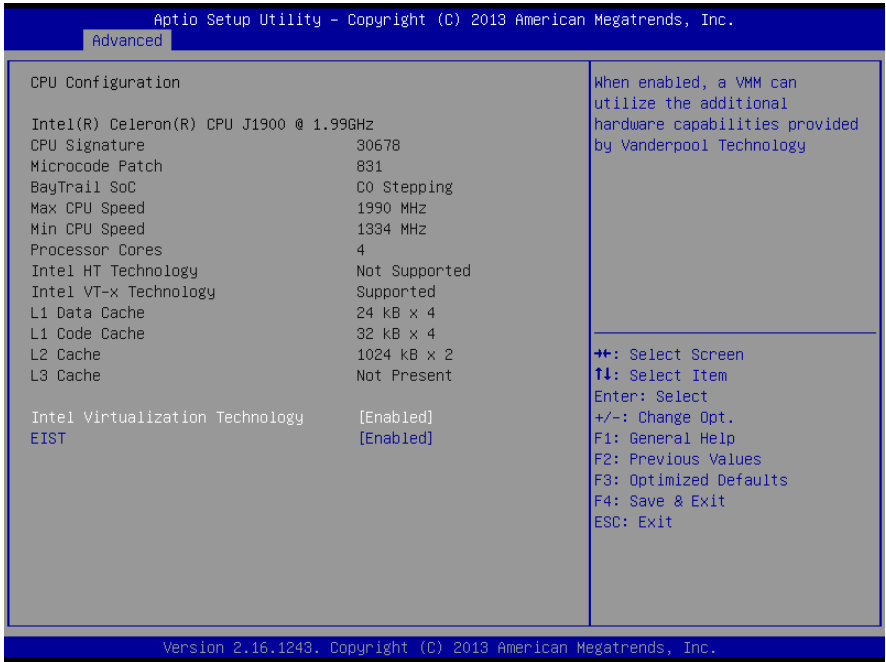

Options summary:

Intel Virtualization Technology	Disabled	
	Enabled	Optimal Default, Failsafe Default
Enable or Disable Intel Virtualization Technology		
EIST	Disabled	
	Enabled	Optimal Default, Failsafe Default
Enable or Disable EIST		

3.4.2 Advanced: IDE Configuration

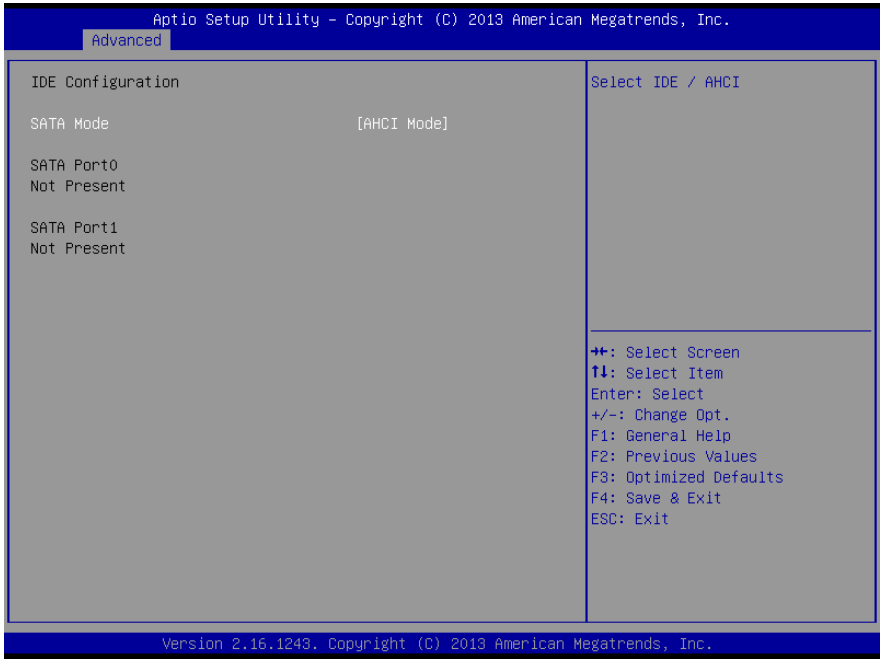

Options summary:

SATA Mode	IDE Mode	Optimal Default, Failsafe Default
	AHCI Mode	

3.4.3 Advanced: USB Configuration

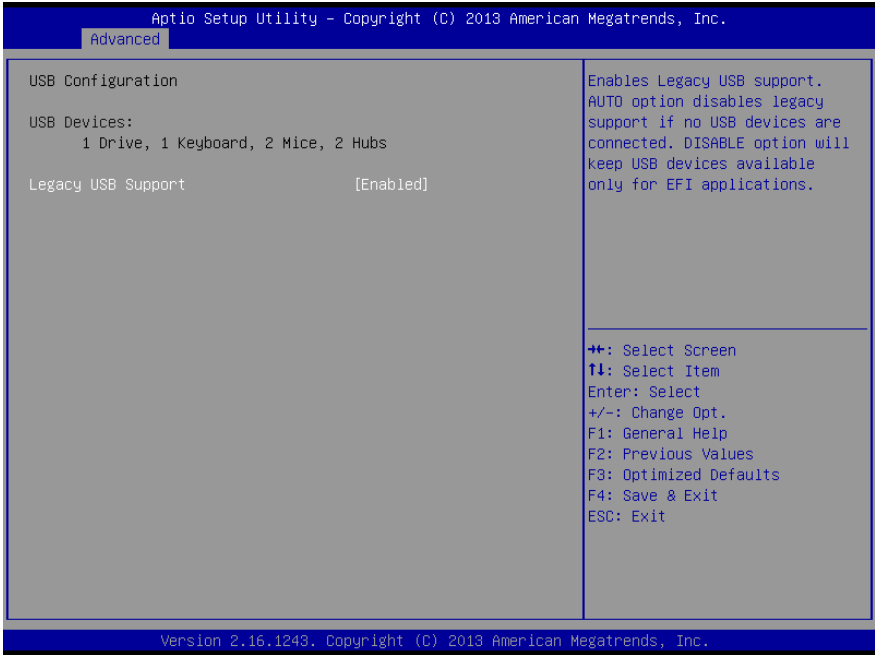

Options summary:

Legacy USB Support	Enabled	Optimal Default, Failsafe Default
	Disabled	
	Auto	
<p>Enables BIOS Support for Legacy USB Support. When enabled, USB can be functional in legacy environment like DOS.</p> <p>AUTO option disables legacy support if no USB devices are connected</p>		

3.4.4 Advanced: Hardware Monitor

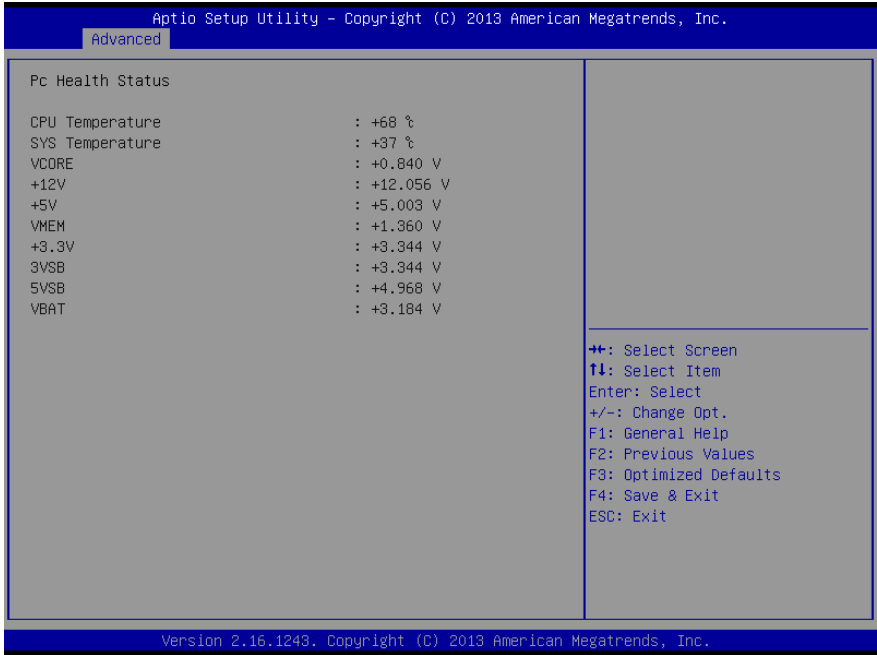

3.4.5 Advanced: Power Management

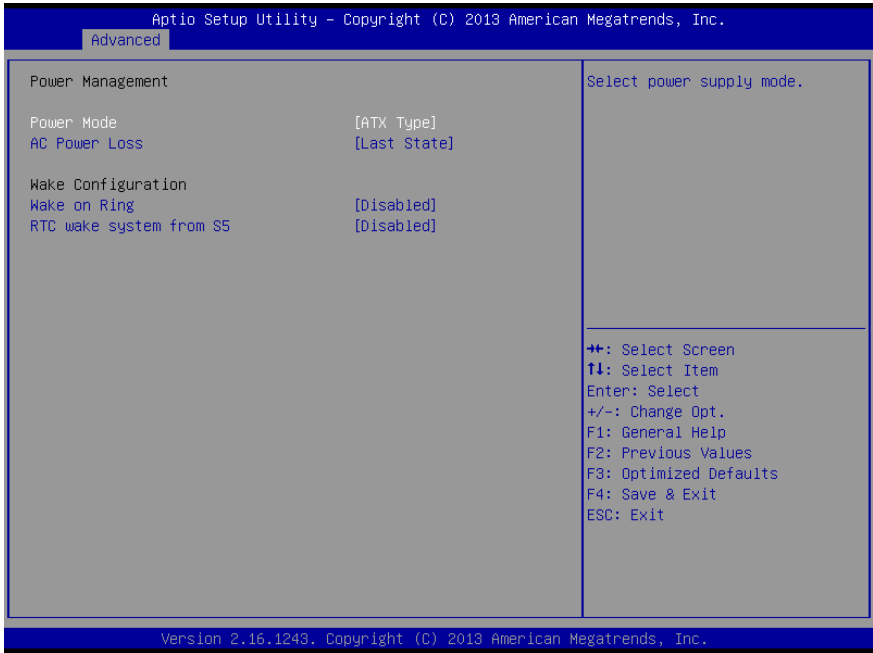

Options summary:

Power Mode	ATX Type	Optimal Default, Failsafe Default
	AT Type	
Select power supply mode.		
AC Power Loss	Last State	Optimal Default, Failsafe Default
	Power On	
	Power Off	
Select power state when power is re-applied after a power failure.		
Wake on Ring	Enable	Optimal Default, Failsafe Default
	Disable	
Enable or disable System wake on Ring.		
RTC wake system from S5	Disabled	Optimal Default, Failsafe Default
	Fixed Time	
	Dynamic Time	
Enable or disable System wake on alarm event. When enabled, System will wake on the hr::min::sec specified		

3.4.6 Advanced: Super IO Management

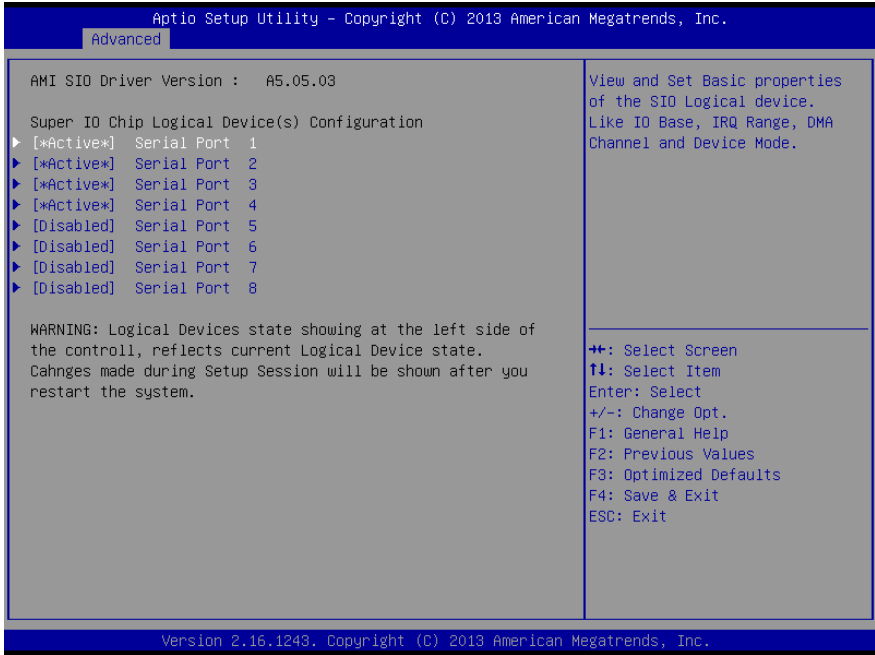

Note: Serial Port 5 ~ 8 are activated with OMNI Module

3.4.6.1 Super IO Management: Serial Port 1 Configuration

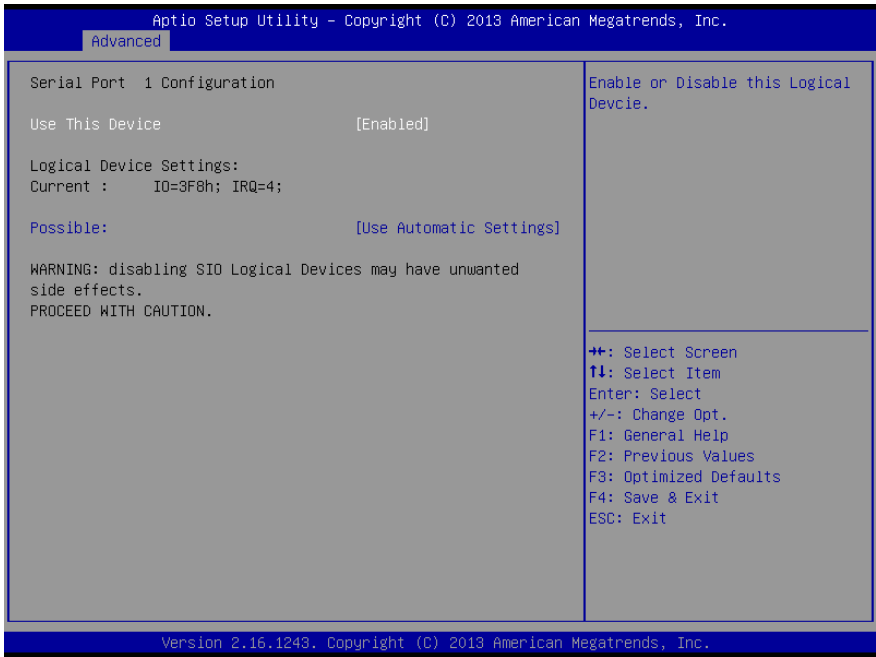

Options summary:

Use This Device	Disabled	Optimal Default, Failsafe Default
	Enabled	
Enable or Disable Serial Port (COM)		
Possible:	Use Automatic Settings	Optimal Default, Failsafe Default
	IO=3F8; IRQ=4;	
	IO=2F8; IRQ=3;	
Select an optimal setting for IO device		

3.4.6.2 Super IO Management: Serial Port 2 Configuration

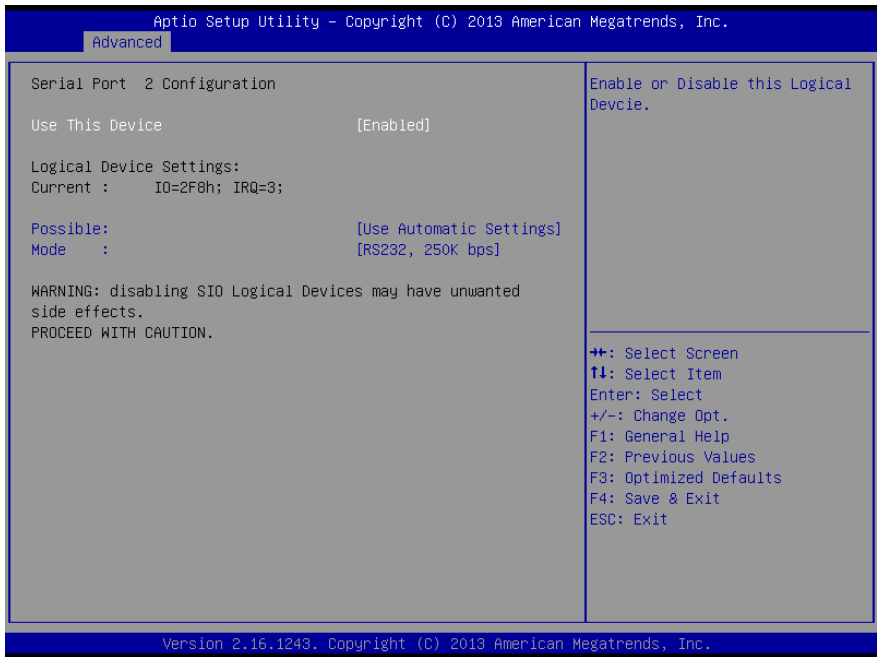

Options summary:

Use This Device	Disabled	Optimal Default, Failsafe Default
	Enabled	
Enable or Disable Serial Port (COM)		
Possible:	Use Automatic Settings	Optimal Default, Failsafe Default
	IO=2F8; IRQ=3;	
	IO=3F8; IRQ=4;	
Select an optimal setting for IO device		
Mode:	RS232, 250K bps	Optimal Default, Failsafe Default
	RS232, 1M bps	
	RS422, 250K bps	
	RS422, 10M bps	
	RS485, Driver Half Duplex, 250K bps	
	RS485, Receiver Half Duplex, 250K bps	
	RS485, Driver Half Duplex, 10M bps	
	RS485, Receiver Half Duplex, 10M bps	
	Shut Down Mode	

3.4.6.3 Super IO Management: Serial Port 3 Configuration

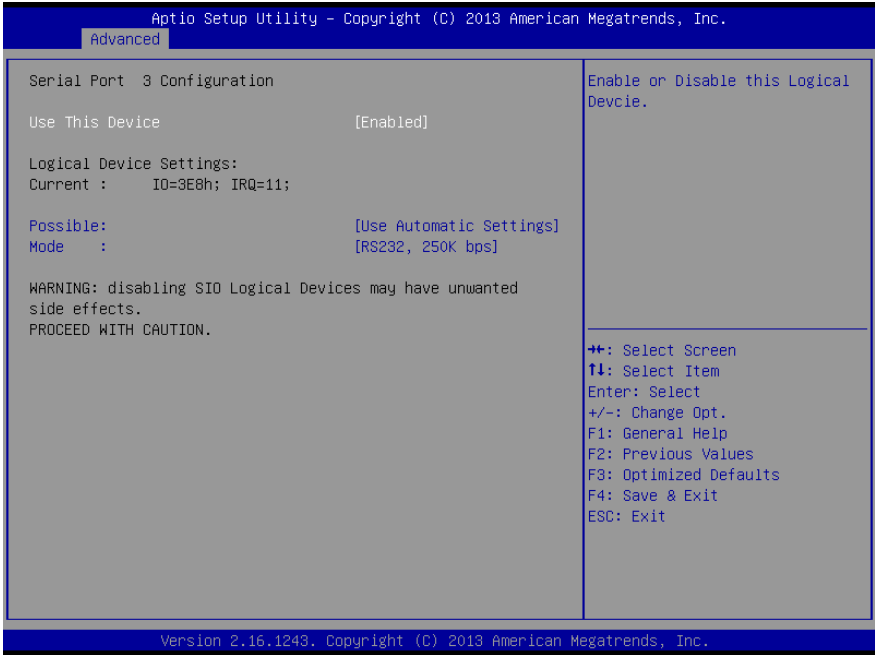

Options summary:

Use This Device	Disabled	Optimal Default, Failsafe Default
	Enabled	
Enable or Disable Serial Port (COM)		
Possible:	Use Automatic Settings	Optimal Default, Failsafe Default
	IO=3E8; IRQ=11;	
	IO=2E8; IRQ=11;	
Select an optimal setting for IO device		
Mode:	RS232, 250K bps	Optimal Default, Failsafe Default
	RS232, 1M bps	
	RS422, 250K bps	
	RS422, 10M bps	
	RS485, Driver Half Duplex, 250K bps	
	RS485, Receiver Half Duplex, 250K bps	
	RS485, Driver Half Duplex, 10M bps	
	RS485, Receiver Half Duplex, 10M bps	

	Shut Down Mode	
--	----------------	--

3.4.6.4 Super IO Management: Serial Port 4 Configuration

Aptio Setup Utility - Copyright (C) 2013 American Megatrends, Inc.

Advanced

<p>Serial Port 4 Configuration</p> <p>Use This Device [Enabled]</p> <p>Logical Device Settings: Current : IO=2E8h; IRQ=11;</p> <p>Possible: [Use Automatic Settings]</p> <p>WARNING: disabling SIO Logical Devices may have unwanted side effects. PROCEED WITH CAUTION.</p>	<p>Enable or Disable this Logical Device.</p> <hr/> <p> ++: Select Screen ↑↓: Select Item Enter: Select +/-: Change Opt. F1: General Help F2: Previous Values F3: Optimized Defaults F4: Save & Exit ESC: Exit </p>
--	---

Version 2.16.1243, Copyright (C) 2013 American Megatrends, Inc.

Options summary:

Use This Device	Disabled	Optimal Default, Failsafe Default
	Enabled	
Enable or Disable Serial Port (COM)		
Possible:	Use Automatic Settings	Optimal Default, Failsafe Default
	IO=2E8; IRQ=11;	
	IO=3E8; IRQ=11;	
Select an optimal setting for IO device		

3.4.6.5 Super IO Management: Serial Port 5 Configuration

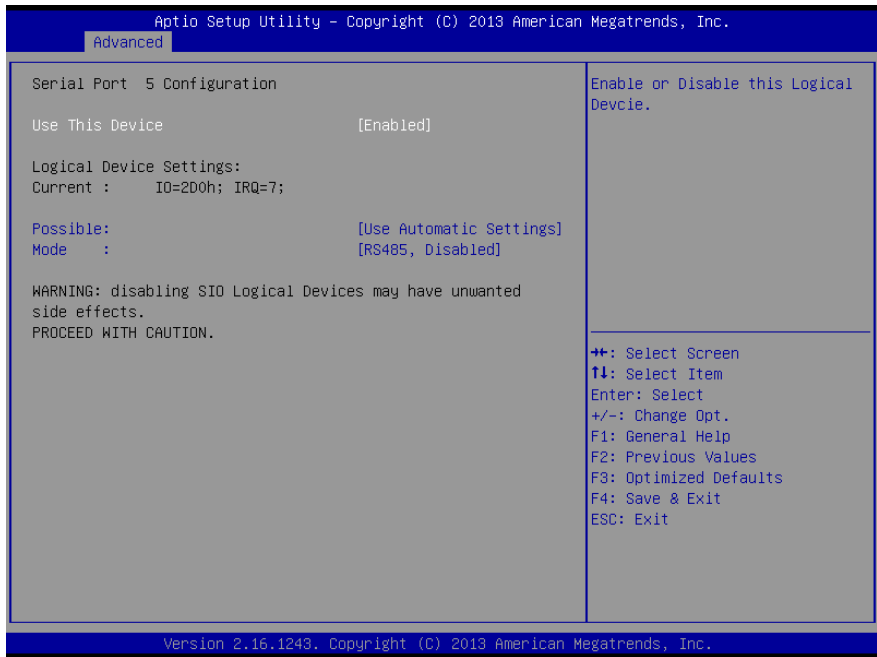

Options summary:

Use This Device	Disabled	Optimal Default, Failsafe Default
	Enabled	
Enable or Disable Serial Port (COM)		
Possible:	Use Automatic Settings	Optimal Default, Failsafe Default
	IO=2D0; IRQ=7;	
	IO=2C0; IRQ=7;	
Select an optimal setting for IO device		
Mode:	RS485, Disabled	Optimal Default, Failsafe Default
	RS485, Enabled	
Set the Serial Mode		

3.4.6.6 Super IO Management: Serial Port 6 Configuration (Optional)

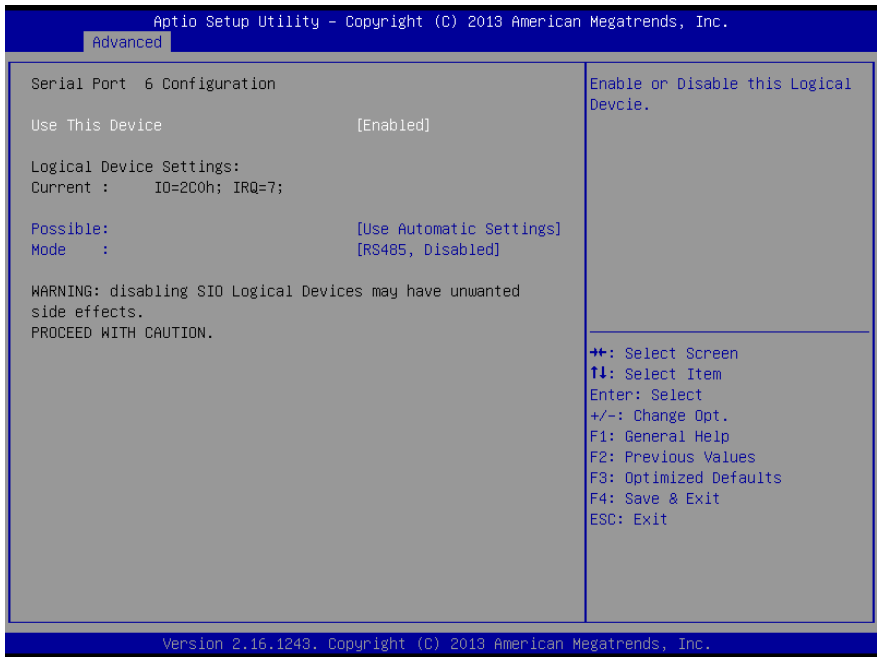

Options summary:

Use This Device	Disabled	Optimal Default, Failsafe Default
	Enabled	
En/Disable Serial Port (COM)		
Possible:	Use Automatic Settings	Optimal Default, Failsafe Default
	IO=2C0; IRQ=7;	
	IO=2D0; IRQ=7;	
Select an optimal setting for IO device		
Mode:	RS485, Disabled	Optimal Default, Failsafe Default
	RS485, Enabled	
Set the Serial Mode		

3.4.6.7 Super IO Management: Serial Port 7 Configuration (Optional)

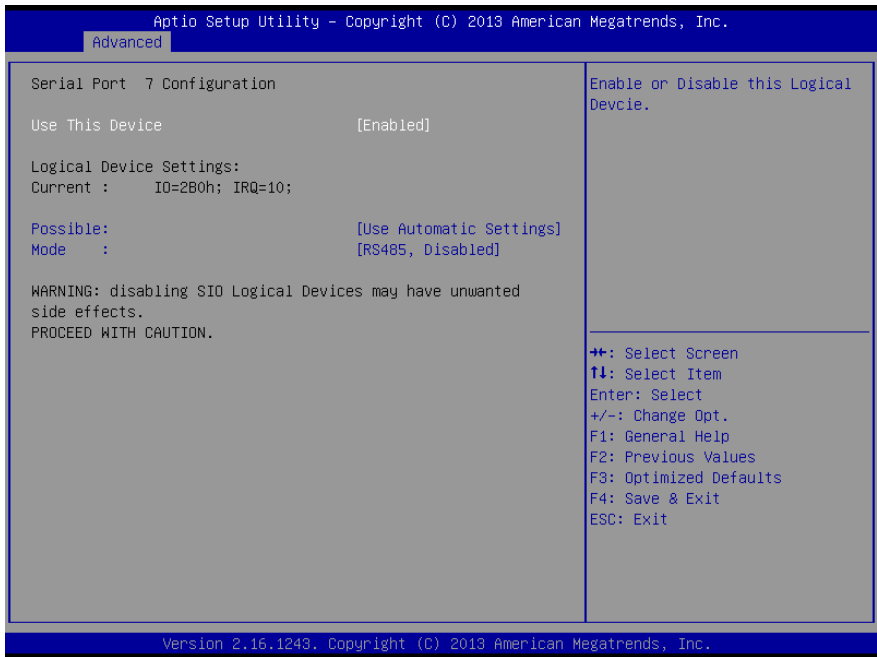

Options summary:

Use This Device	Disabled	Optimal Default, Failsafe Default
	Enabled	
En/Disable Serial Port (COM)		
Possible:	Use Automatic Settings	Optimal Default, Failsafe Default
	IO=2B0; IRQ=10;	
	IO=2B8; IRQ=10;	
Select an optimal setting for IO device		
Mode:	RS485, Disabled	Optimal Default, Failsafe Default
	RS485, Enabled	
Set the Serial Mode		

3.4.6.8 Super IO Management: Serial Port 8 Configuration (Optional)

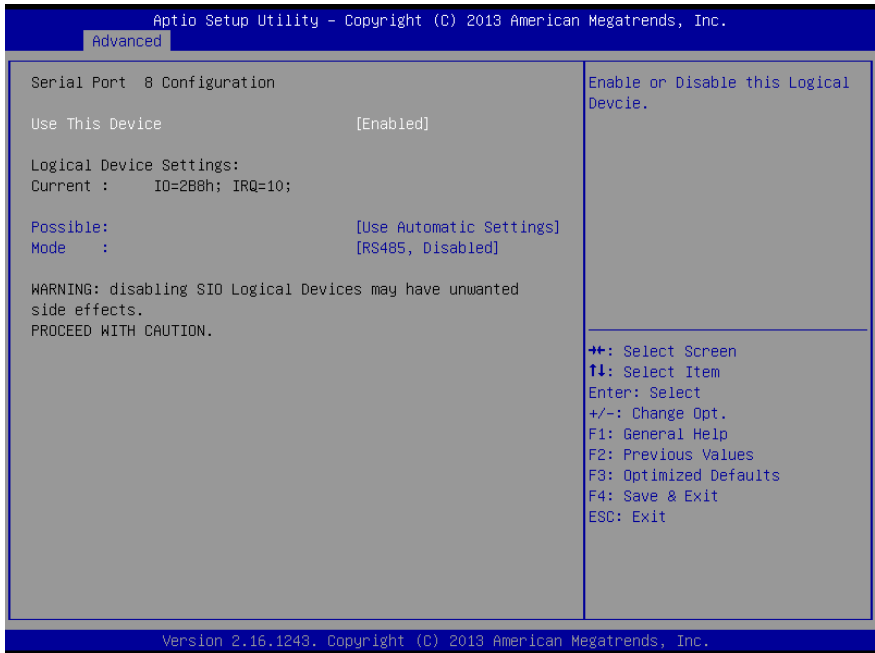

Options summary:

Use This Device	Disabled	Optimal Default, Failsafe Default
	Enabled	
En/Disable Serial Port (COM)		
Possible:	Use Automatic Settings	Optimal Default, Failsafe Default
	IO=2B8; IRQ=10;	
	IO=2B0; IRQ=10;	
Select an optimal setting for IO device		
Mode:	RS485, Disabled	Optimal Default, Failsafe Default
	RS485, Enabled	
Set the Serial Mode		

3.5 Setup submenu: Chipset

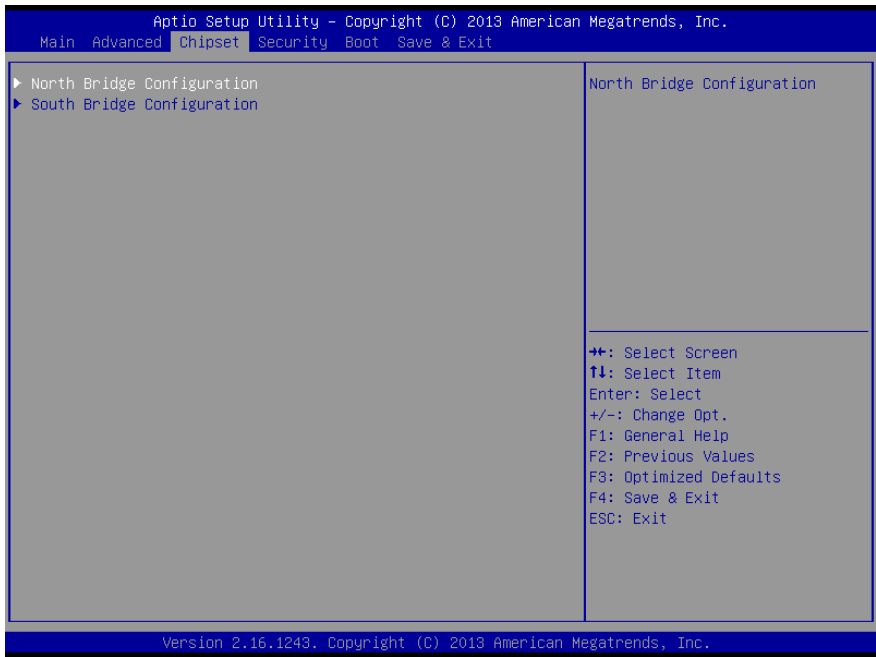

3.5.1 Chipset: North Bridge

Aptio Setup Utility - Copyright (C) 2013 American Megatrends, Inc.

Chipset

North Bridge Configuration

Memory Information

Total Memory 2048 MB (LPDDR3)

Memory Slot0 2048 MB (LPDDR3)

▶ Display Control Configuration

Display Control Configuration

+/: Select Screen
↑↓: Select Item
Enter: Select
+/-: Change Opt.
F1: General Help
F2: Previous Values
F3: Optimized Defaults
F4: Save & Exit
ESC: Exit

Version 2.16.1243. Copyright (C) 2013 American Megatrends, Inc.

3.5.1.1 North Bridge: Display Control Configuration

Aptio Setup Utility - Copyright (C) 2013 American Megatrends, Inc.

Chipset

Display Control Configuration		Select DVMT 5.0 Pre-Allocated (Fixed) Graphics Memory size used by the Internal Graphics Device.
DVMT Pre-Allocated	[64M]	++: Select Screen ↑↓: Select Item Enter: Select +/-: Change Opt. F1: General Help F2: Previous Values F3: Optimized Defaults F4: Save & Exit ESC: Exit
DVMT Total Gfx Mem	[256MB]	
Primary IGFX Boot Display	[LVDS]	
Secondary IGFX Boot Display	[CRT]	
LVDS	[Enabled]	
LVDS Panel Type	[1366x768,60Hz]	
Color Depth	[24bit]	
Panel Mode	[Single channel]	
Data enable polarity	[Active low]	
LVDS Backlight Level	[80%]	
LVDS Backlight Type	[Normal]	

Version 2.16.1243. Copyright (C) 2013 American Megatrends, Inc.

Options summary:

DVMT Pre-Allocated	64M	Optimal Default, Failsafe Default
	96M	
	128M	
	160M	
	192M	
	224M	
	256M	
	288M	
	320M	
	352M	
384M		
416M		
448M		
480M		
512M		
DVMT Total Gfx Mem	128MB	Optimal Default, Failsafe Default
	256MB	

	Max	
Primary IGFX Boot Display	VBIOS default	Optimal Default, Failsafe Default
	CRT	
	HDMI	
	LVDS	
Secondary IGFX Boot Display	Disable	Optimal Default, Failsafe Default
	CRT	
	HDMI	
	LVDS	
LVDS	Disabled	Optimal Default, Failsafe Default
	Enabled	
LVDS Panel Type	640x480, 60Hz	Optimal Default, Failsafe Default
	800x480, 60Hz	
	800x600,60Hz	
	1024x600,60Hz	
	1024x768,60Hz	
	1280x768,60Hz	
	1280x1024,60Hz	
	1366x768,60Hz	
	1440x900,60Hz	
	1600x1200,60Hz	
	1920x1080,60Hz	
	1920x1200,60Hz	
	1280x800,60Hz	
1024x600,80Hz		
Color Depth	24bit	Optimal Default, Failsafe Default
	18bit	
Panel Mode	Single Channel	Optimal Default, Failsafe Default
	Dual Channel	
Data enable polarity	Active Low	Optimal Default, Failsafe Default
	Active High	
LVDS Backlight Level	100%	Optimal Default, Failsafe Default
	90%	
	80%	
	70%	
	60%	
	50%	
	40%	
	30%	
20%		

	10%	
	0%	
LVDS Backlight Control	Normal	Optimal Default, Failsafe Default

3.5.2 Chipset: South Bridge

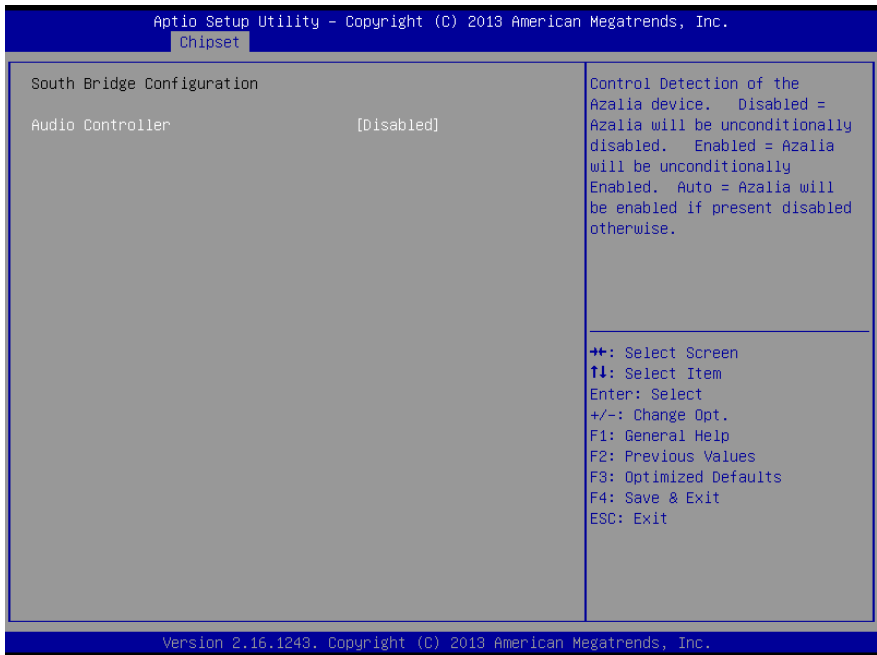

Options summary:

Audio Controller	Disabled	Optimal Default, Failsafe Default
	Enabled	

3.6 Setup submenu: Security

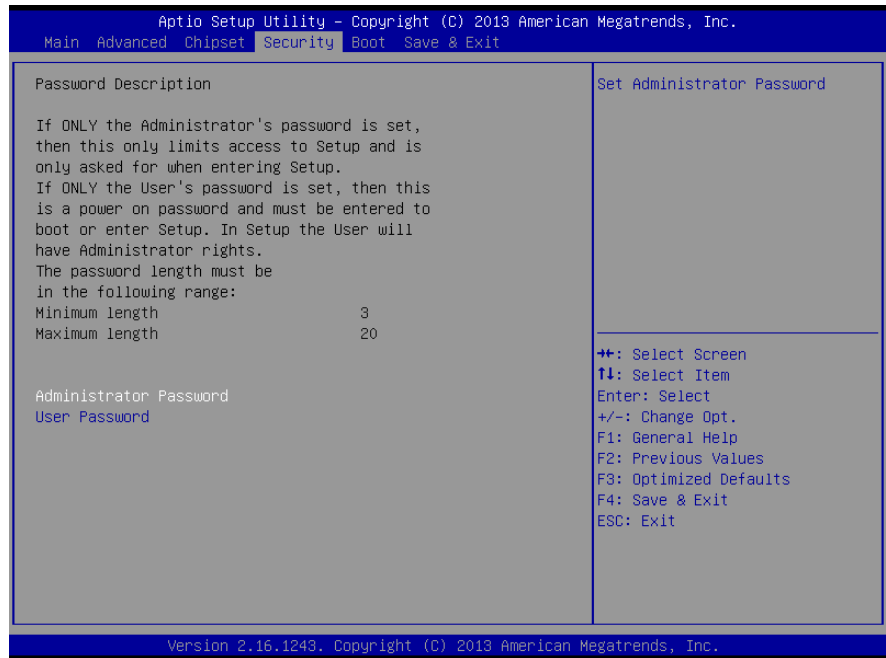

Change User/Administrator Password

You can set a User Password once an Administrator Password is set. The password will be required during boot up, or when the user enters the Setup utility. Please Note that a User Password does not provide access to many of the features in the Setup utility.

Select the password you wish to set, press Enter to open a dialog box to enter your password (you can enter no more than six letters or numbers). Press Enter to confirm your entry, after which you will be prompted to retype your password for a final confirmation. Press Enter again after you have retyped it correctly.

Removing the Password

Highlight this item and type in the current password. At the next dialog box press Enter to disable password protection.

3.7 Setup submenu: Boot

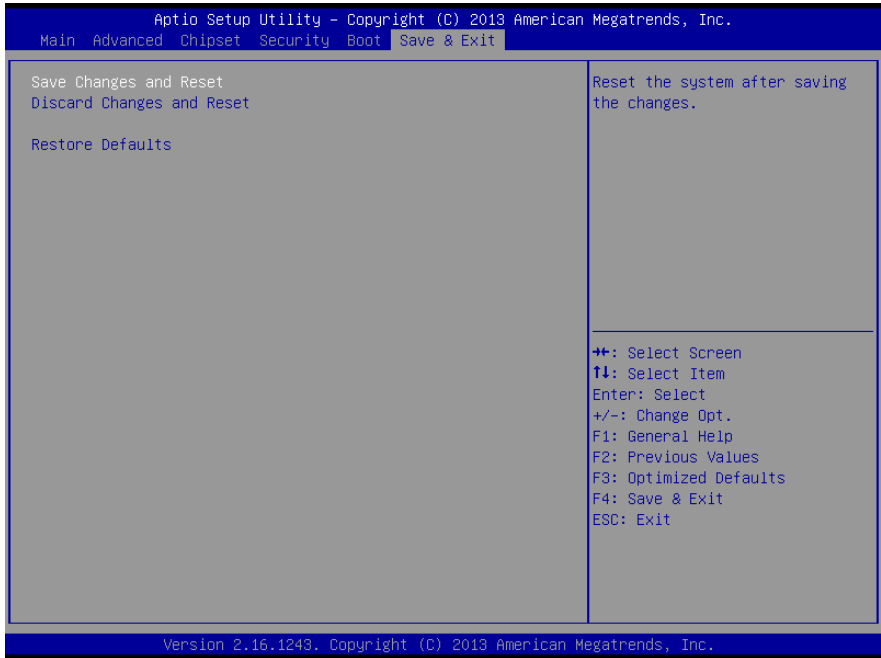

Options summary:

Quiet Boot	Disabled	Optimal Default, Failsafe Default
	Enabled	
En/Disable showing boot logo.		
Option ROM Messages	Force BIOS	Optimal Default, Failsafe Default
	Keep Current	
Set display mode for Option ROM		
Launch PXE OpROM	Disabled	Optimal Default, Failsafe Default
	Enabled	
En/Disable Legacy Boot Option		

3.8 Boot: BBS Priorities

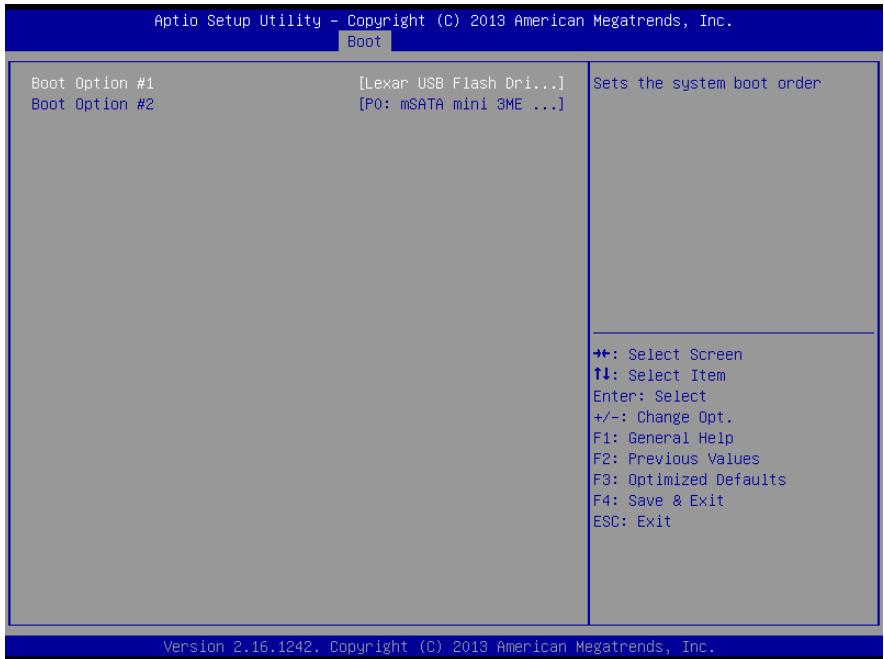

3.9 Setup submenu: Exit

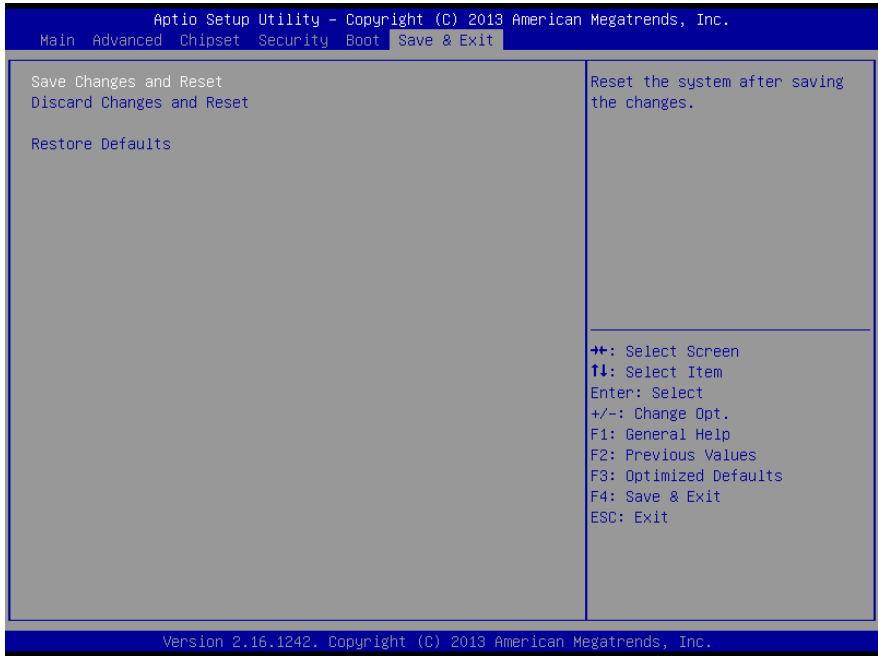

Chapter 4

Drivers Installation & Touchscreen Settings

4.1 Product CD/DVD

The OMNI-2155 comes with a product DVD that contains all the drivers and utilities you need to setup your product. Insert the DVD and follow the steps in the autorun program to install the drivers.

In case the program does not start, follow the sequence below to install the drivers.

Step 1 – Install Chipset Drivers

1. Open the **Step 1 – Chipset** folder and select your OS
2. Open the **SetupChipset.exe** file in the folder
3. Follow the instructions
4. Drivers will be installed automatically

Step 2 – Install Graphics Driver

1. Open the **STEP2 - VGA** folder and select your OS
2. Open the **Setup.exe** file in the folder
3. Follow the instructions
4. Drivers will be installed automatically

Step 3 – Install LAN Driver

1. Open the **STEP3 – LAN** folder and select your OS
2. Open the **.exe** file in the folder
3. Follow the instructions
4. Drivers will be installed automatically

Step 4 – Install TXE Driver (Windows 8 only)

1. Open the **STEP4 – TXE** folder and select your OS

2. Open the **SetupTXE.exe** file in the folder
3. Follow the instructions
4. Drivers will be installed automatically

Step 5 – Install USB 3.0 Drivers (Windows 7 only)

1. Open the **STEP5 - USB3.0** folder followed by **Setup.exe**
2. Follow the instructions
3. Drivers will be installed automatically

Step 6 – Install MBI Drivers (Optional, Windows 8.1/ 10 only)

1. Open the **STEP6 – MBI (Optional)** folder and select your OS
2. Open the **Setup.exe** file in the folder
3. Follow the instructions
4. Drivers will be installed automatically

Step 7 – Install PenMount Touch 6000 Series Driver (Resistive touchscreen only)

1. Open the **STEP7 –PenMount Touch 6000** folder followed by **Setup.exe**
2. Follow the instructions
3. Drivers will be installed automatically

* The OMNI-2155 uses either 5-wire resistive or projected capacitive multi-touch technologies. The latter is capable of 10 fingers multi-touch with Windows 7 & Windows 8.x support.

Step 8 – Serial Port Drivers (Optional)

1. For Windows 7:
2. Change User Account **Control** settings to **Never notify**

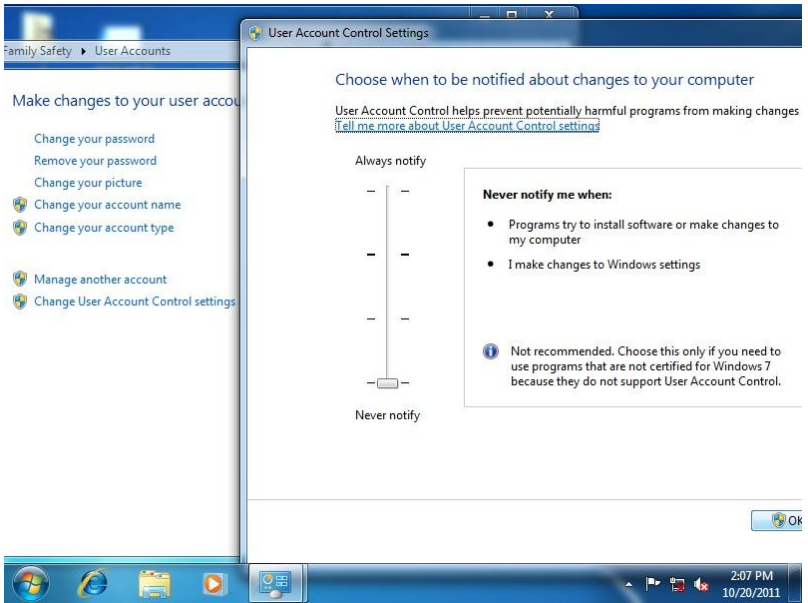

3. Reboot and log in as administrator

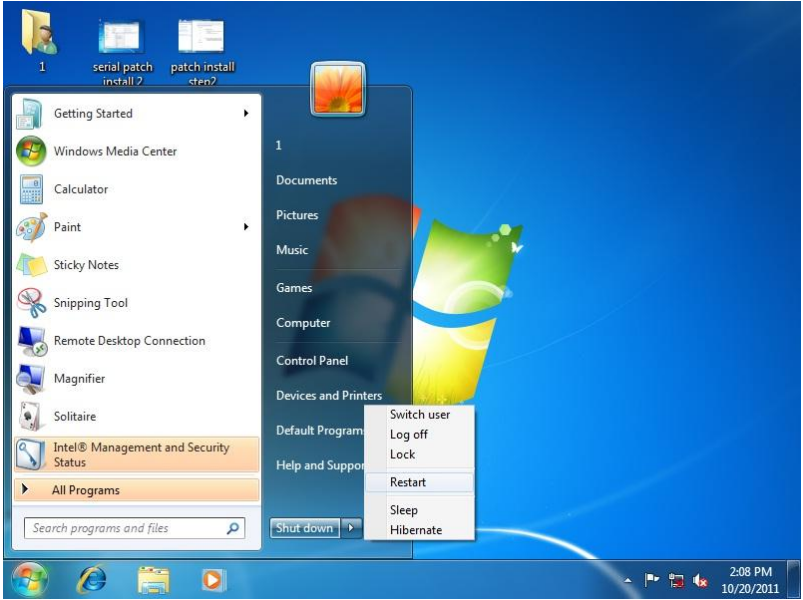

4. Run patch.bat as administrator

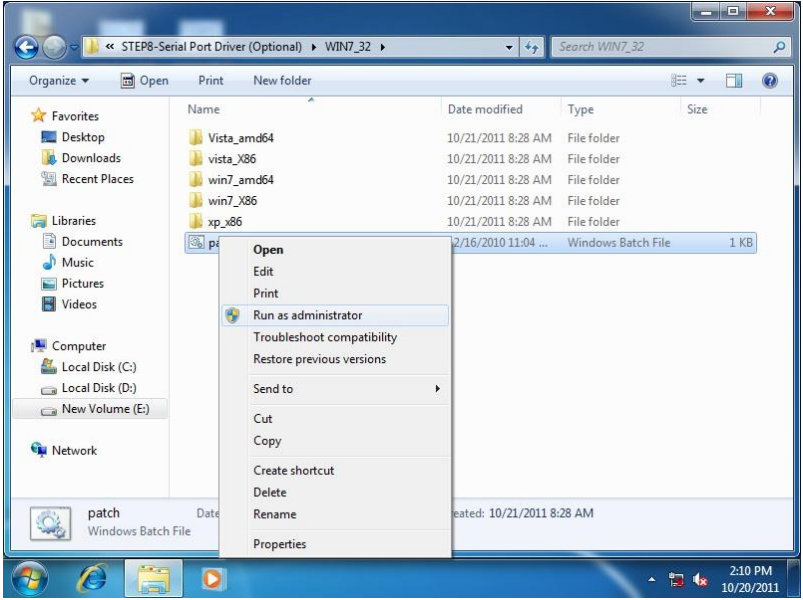

For Windows 8:

1. Open the Apps Screen, right click on the **Command Prompt** tile and select **Run as Administrator**

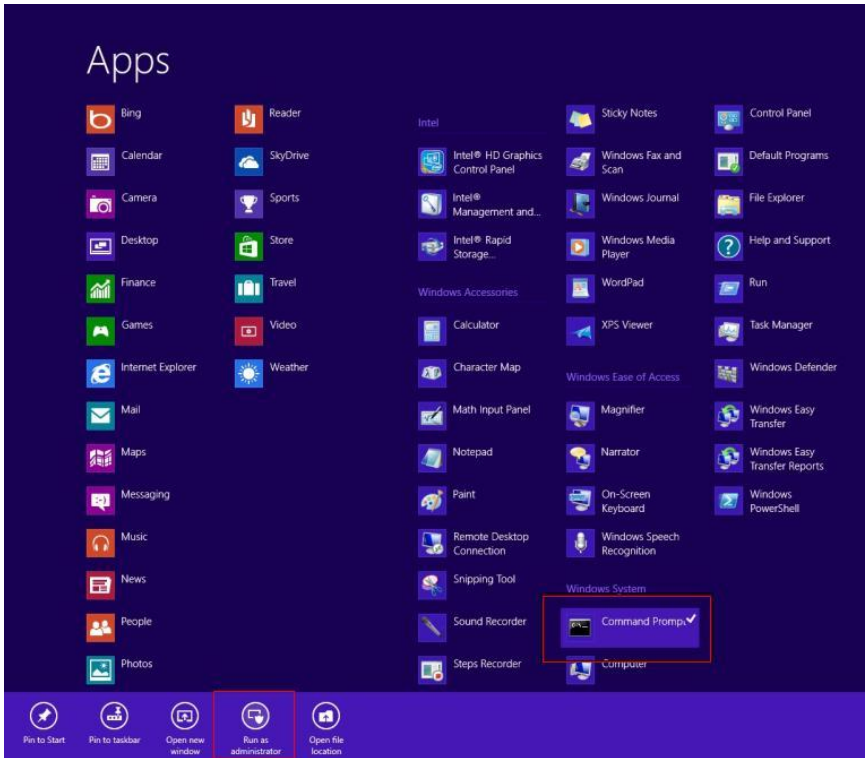

- To install the driver (patch.bat), you will first have to locate the file in command prompt. To do that, first go to the directory which contains the file by entering **<drive letter>: eg.** if the driver is in D drive, enter **D:**
- You are now at the directory containing the installation file. Next, go to the folder in which the file resides by entering **cd <folder>** eg: if the file is in a folder named abc, enter **cd <abc>**.
- You are now at the folder where the file is located. Enter the **patch.bat** to open and install the drivers. If your file is in a subfolder, enter the **cd <folder>** command again to access the subfolder (screenshot below is for reference only).

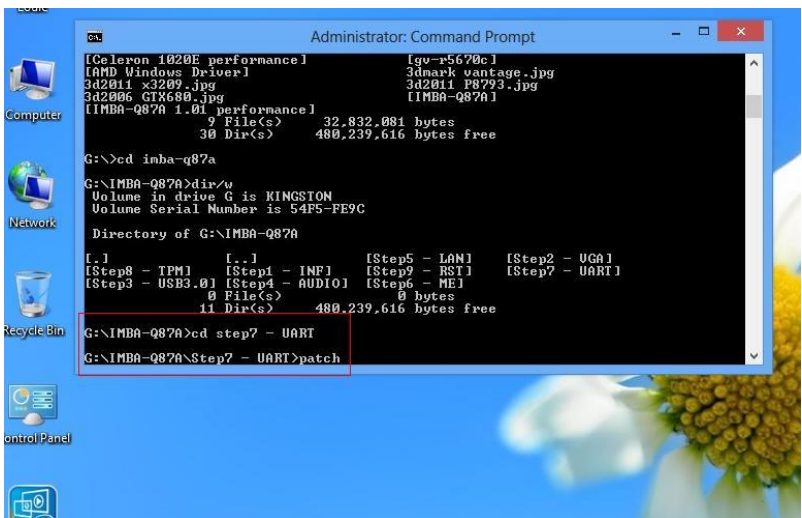

- Reboot after installation completes.
- To confirm the installation, go to Device Manager, expand the Ports (COM & LPT) tree and double click on any of the COM ports to open its properties. Go to the Driver tab, select Driver Details and click on **serial.sys**, you should see its provider as **Windows (R) Win 7 DDK Provider**.

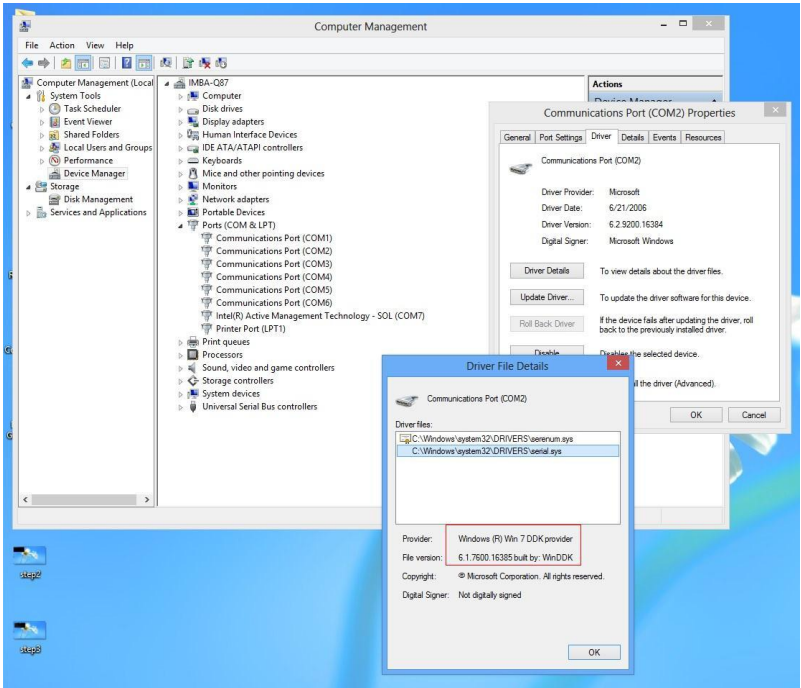

For Windows 10

1. Open the **STEP8 – Serial Port Driver (Optional)** folder and select **Win10_32_64**
2. Open the **Setup.exe** file in the folder
3. Follow the instructions
4. Drivers will be installed automatically

4.2 PCAP Dual Monitor Touch Settings

When two panels are used, they can set to be the primary and secondary display. The instruction below shows how this can be done:

1. Go to Display Panel and choose your preferred primary display.

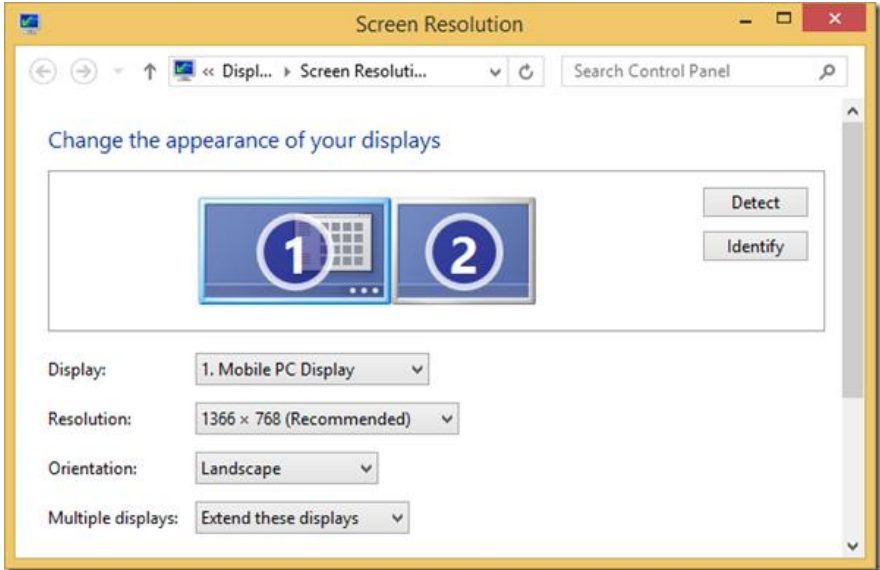

- Go to **Tablet PC Settings** in **Control Panel**. Under **Display options**, select the primary display from step 1. Apply the changes and exit.

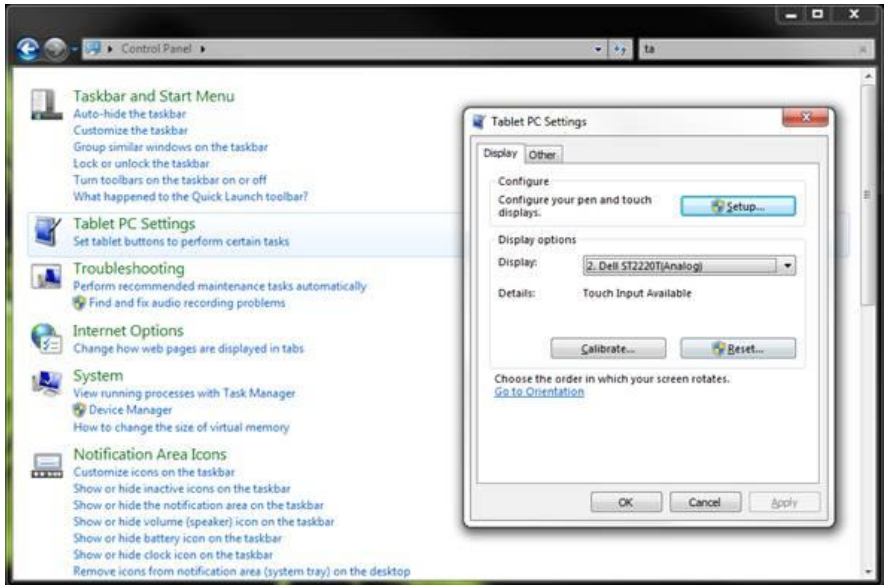

*Do NOT calibrate the screen on your own. Doing so might disrupt the device's factory calibration

Appendix A

Watchdog Timer Programming

A.1 Watchdog Timer Initial Program

Table 1 : Super I/O relative register table		
	Default Value	Note
Index	0x2E(Note1)	SIO MB PnP Mode Index Register 0x2E or 0x4E
Data	0x2F(Note2)	SIO MB PnP Mode Data Register 0x2F or 0x4F

Table 2 : Watchdog relative register table					
	LDN	Register	BitNum	Value	Note
Timer Counter	0x07(Note3)	0xF6(Note4)		(Note24)	Time of watchdog timer (0~255) This register is byte access
Counting Unit	0x07(Note5)	0xF5(Note6)	3(Note7)	0(Note8)	Select time unit. 0: second 1: minute
Watchdog Enable	0x07(Note9)	0xF5(Note10)	5(Note11)	1(Note12)	0: Disable 1: Enable
Timeout Status	0x07(Note13)	0xF5(Note14)	6(Note15)	1	1: Clear timeout status
Output Mode	0x07(Note16)	0xF5(Note17)	4(Note18)	1(Note19)	Select WDTRST# output mode 0: level 1: pulse
WDTRST output	0x07(Note20)	0xFA(Note21)	0(Note22)	1(Note23)	Enable/Disable time out output via WDTRST# 0: Disable 1: Enable

```

*****
// SuperIO relative definition (Please reference to Table 1)
#define byte SIOIndex //This parameter is represented from Note1
#define byte SIOData //This parameter is represented from Note2
#define void IOWriteByte(byte IOPort, byte Value);
#define byte IOReadByte(byte IOPort);
// Watch Dog relative definition (Please reference to Table 2)
#define byte TimerLDN //This parameter is represented from Note3
#define byte TimerReg //This parameter is represented from Note4
#define byte TimerVal // This parameter is represented from Note24
#define byte UnitLDN //This parameter is represented from Note5
#define byte UnitReg //This parameter is represented from Note6
#define byte UnitBit //This parameter is represented from Note7
#define byte UnitVal //This parameter is represented from Note8
#define byte EnableLDN //This parameter is represented from Note9
#define byte EnableReg //This parameter is represented from Note10
#define byte EnableBit //This parameter is represented from Note11
#define byte EnableVal //This parameter is represented from Note12
#define byte StatusLDN // This parameter is represented from Note13
#define byte StatusReg // This parameter is represented from Note14
#define byte StatusBit // This parameter is represented from Note15
#define byte ModeLDN // This parameter is represented from Note16
#define byte ModeReg // This parameter is represented from Note17
#define byte ModeBit // This parameter is represented from Note18
#define byte ModeVal // This parameter is represented from Note19
#define byte WDTRstLDN // This parameter is represented from Note20
#define byte WDTRstReg // This parameter is represented from Note21
#define byte WDTRstBit // This parameter is represented from Note22
#define byte WDTRstVal // This parameter is represented from Note23
*****

```

Appendix B

I/O Information

B.1 I/O Address Map

Input/output (I/O)	
[0000000000000000 - 000000000000006F]	PCI bus
[0000000000000020 - 0000000000000021]	Programmable interrupt controller
[0000000000000024 - 0000000000000025]	Programmable interrupt controller
[0000000000000028 - 0000000000000029]	Programmable interrupt controller
[000000000000002C - 000000000000002D]	Programmable interrupt controller
[000000000000002E - 000000000000002F]	Motherboard resources
[0000000000000030 - 0000000000000031]	Programmable interrupt controller
[0000000000000034 - 0000000000000035]	Programmable interrupt controller
[0000000000000038 - 0000000000000039]	Programmable interrupt controller
[000000000000003C - 000000000000003D]	Programmable interrupt controller
[0000000000000040 - 0000000000000043]	System timer
[000000000000004E - 000000000000004F]	Motherboard resources
[0000000000000050 - 0000000000000053]	System timer
[0000000000000060 - 0000000000000060]	Standard PS/2 Keyboard
[0000000000000061 - 0000000000000061]	Motherboard resources
[0000000000000063 - 0000000000000063]	Motherboard resources
[0000000000000064 - 0000000000000064]	Standard PS/2 Keyboard
[0000000000000065 - 0000000000000065]	Motherboard resources
[0000000000000067 - 0000000000000067]	Motherboard resources
[0000000000000070 - 0000000000000070]	Motherboard resources
[0000000000000070 - 0000000000000077]	System CMOS/real time clock
[0000000000000078 - 000000000000007F]	PCI bus
[0000000000000080 - 000000000000008F]	Motherboard resources
[0000000000000092 - 0000000000000092]	Motherboard resources
[00000000000000A0 - 00000000000000A1]	Programmable interrupt controller
[00000000000000A4 - 00000000000000A5]	Programmable interrupt controller
[00000000000000A8 - 00000000000000A9]	Programmable interrupt controller
[00000000000000AC - 00000000000000AD]	Programmable interrupt controller
[00000000000000B0 - 00000000000000B1]	Programmable interrupt controller
[00000000000000B2 - 00000000000000B3]	Motherboard resources
[00000000000000B4 - 00000000000000B5]	Programmable interrupt controller
[00000000000000B8 - 00000000000000B9]	Programmable interrupt controller
[00000000000000BC - 00000000000000BD]	Programmable interrupt controller
[00000000000002E8 - 00000000000002EF]	Communications Port (COM4)
[00000000000002F8 - 00000000000002FF]	Communications Port (COM2)
[00000000000003B0 - 00000000000003BB]	Intel(R) HD Graphics
[00000000000003C0 - 00000000000003DF]	Intel(R) HD Graphics
[00000000000003E8 - 00000000000003EF]	Communications Port (COM3)
[00000000000003F8 - 00000000000003FF]	Communications Port (COM1)
[0000000000000400 - 000000000000047F]	Motherboard resources
[00000000000004D0 - 00000000000004D1]	Programmable interrupt controller
[0000000000000500 - 00000000000005FE]	Motherboard resources
[0000000000000600 - 000000000000061F]	Motherboard resources
[0000000000000680 - 000000000000069F]	Motherboard resources
[0000000000000A00 - 0000000000000A0F]	Motherboard resources
[0000000000000A10 - 0000000000000A1F]	Motherboard resources
[0000000000000A20 - 0000000000000A2F]	Motherboard resources

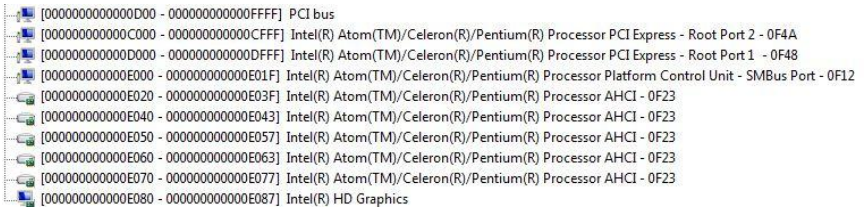



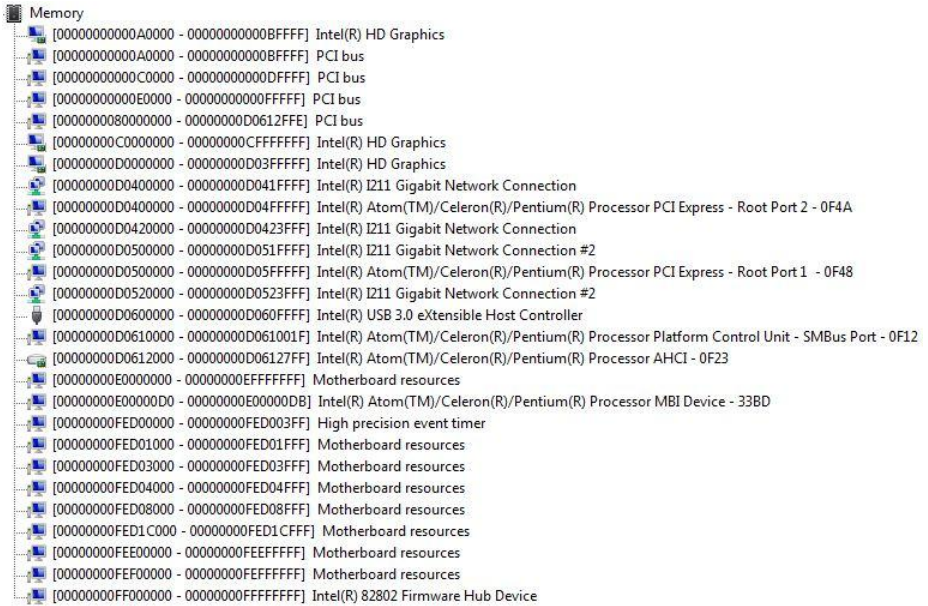









































B.2 Memory Address Map

































































































The image shows a screenshot of the Windows System Information tool, specifically the 'Memory' section. It displays a list of memory addresses and their corresponding hardware components. The list includes various Intel(R) HD Graphics, PCI bus, Intel(R) HD Graphics, Intel(R) I211 Gigabit Network Connection, Intel(R) Atom(TM)/Celeron(R)/Pentium(R) Processor PCI Express - Root Port 2 - 0F4A, Intel(R) I211 Gigabit Network Connection, Intel(R) I211 Gigabit Network Connection #2, Intel(R) Atom(TM)/Celeron(R)/Pentium(R) Processor PCI Express - Root Port 1 - 0F48, Intel(R) Atom(TM)/Celeron(R)/Pentium(R) Processor PCI Express - Root Port 2 - 0F48, Intel(R) USB 3.0 eXtensible Host Controller, Intel(R) Atom(TM)/Celeron(R)/Pentium(R) Processor Platform Control Unit - SMBus Port - 0F12, Intel(R) Atom(TM)/Celeron(R)/Pentium(R) Processor AHCI - 0F23, Motherboard resources, Intel(R) Atom(TM)/Celeron(R)/Pentium(R) Processor MBI Device - 33BD, High precision event timer, and Intel(R) 82802 Firmware Hub Device.

Memory Address	Hardware Component
[0000000000A0000 - 0000000000BFFFF]	Intel(R) HD Graphics
[0000000000A0000 - 0000000000BFFFF]	PCI bus
[0000000000C0000 - 0000000000DFFFF]	PCI bus
[0000000000E0000 - 0000000000FFFFFF]	PCI bus
[0000000080000000 - 00000000D0612FFE]	PCI bus
[00000000C0000000 - 00000000CFFFFFFF]	Intel(R) HD Graphics
[00000000D0000000 - 00000000D03FFFFFFF]	Intel(R) HD Graphics
[00000000D0400000 - 00000000D041FFFFF]	Intel(R) I211 Gigabit Network Connection
[00000000D0400000 - 00000000D04FFFFFFF]	Intel(R) Atom(TM)/Celeron(R)/Pentium(R) Processor PCI Express - Root Port 2 - 0F4A
[00000000D0420000 - 00000000D0423FFFF]	Intel(R) I211 Gigabit Network Connection
[00000000D0500000 - 00000000D051FFFFF]	Intel(R) I211 Gigabit Network Connection #2
[00000000D0500000 - 00000000D05FFFFFFF]	Intel(R) Atom(TM)/Celeron(R)/Pentium(R) Processor PCI Express - Root Port 1 - 0F48
[00000000D0520000 - 00000000D0523FFFF]	Intel(R) I211 Gigabit Network Connection #2
[00000000D0600000 - 00000000D060FFFFF]	Intel(R) USB 3.0 eXtensible Host Controller
[00000000D0610000 - 00000000D061001F]	Intel(R) Atom(TM)/Celeron(R)/Pentium(R) Processor Platform Control Unit - SMBus Port - 0F12
[00000000D0612000 - 00000000D06127FFF]	Intel(R) Atom(TM)/Celeron(R)/Pentium(R) Processor AHCI - 0F23
[00000000E0000000 - 00000000EFFFFFFF]	Motherboard resources
[00000000E00000D0 - 00000000E00000DB]	Intel(R) Atom(TM)/Celeron(R)/Pentium(R) Processor MBI Device - 33BD
[00000000FED00000 - 00000000FED003FF]	High precision event timer
[00000000FED01000 - 00000000FED01FFF]	Motherboard resources
[00000000FED03000 - 00000000FED03FFF]	Motherboard resources
[00000000FED04000 - 00000000FED04FFF]	Motherboard resources
[00000000FED08000 - 00000000FED08FFF]	Motherboard resources
[00000000FED1C000 - 00000000FED1CFFF]	Motherboard resources
[00000000FEE00000 - 00000000FEEFFFFFFF]	Motherboard resources
[00000000FEF00000 - 00000000FEFFFFFFF]	Motherboard resources
[00000000FF000000 - 00000000FFFFFFFF]	Intel(R) 82802 Firmware Hub Device

B.3 IRQ Mapping Chart

Interrupt request (IRQ)	
 (ISA) 0x00000000 (00)	System timer
 (ISA) 0x00000001 (01)	Standard PS/2 Keyboard
 (ISA) 0x00000003 (03)	Communications Port (COM2)
 (ISA) 0x00000004 (04)	Communications Port (COM1)
 (ISA) 0x00000008 (08)	High precision event timer
 (ISA) 0x0000000B (11)	Communications Port (COM3)
 (ISA) 0x0000000B (11)	Communications Port (COM4)
 (ISA) 0x0000000C (12)	Microsoft PS/2 Mouse
 (ISA) 0x00000051 (81)	Microsoft ACPI-Compliant System
 (ISA) 0x00000052 (82)	Microsoft ACPI-Compliant System
 (ISA) 0x00000053 (83)	Microsoft ACPI-Compliant System
 (ISA) 0x00000054 (84)	Microsoft ACPI-Compliant System
 (ISA) 0x00000055 (85)	Microsoft ACPI-Compliant System
 (ISA) 0x00000056 (86)	Microsoft ACPI-Compliant System
 (ISA) 0x00000057 (87)	Microsoft ACPI-Compliant System
 (ISA) 0x00000058 (88)	Microsoft ACPI-Compliant System
 (ISA) 0x00000059 (89)	Microsoft ACPI-Compliant System
 (ISA) 0x0000005A (90)	Microsoft ACPI-Compliant System
 (ISA) 0x0000005B (91)	Microsoft ACPI-Compliant System
 (ISA) 0x0000005C (92)	Microsoft ACPI-Compliant System
 (ISA) 0x0000005D (93)	Microsoft ACPI-Compliant System
 (ISA) 0x0000005E (94)	Microsoft ACPI-Compliant System
 (ISA) 0x0000005F (95)	Microsoft ACPI-Compliant System
 (ISA) 0x00000060 (96)	Microsoft ACPI-Compliant System
 (ISA) 0x00000061 (97)	Microsoft ACPI-Compliant System
 (ISA) 0x00000062 (98)	Microsoft ACPI-Compliant System
 (ISA) 0x00000063 (99)	Microsoft ACPI-Compliant System
 (ISA) 0x00000064 (100)	Microsoft ACPI-Compliant System
 (ISA) 0x00000065 (101)	Microsoft ACPI-Compliant System
 (ISA) 0x00000066 (102)	Microsoft ACPI-Compliant System
 (ISA) 0x00000067 (103)	Microsoft ACPI-Compliant System
 (ISA) 0x00000068 (104)	Microsoft ACPI-Compliant System
 (ISA) 0x00000069 (105)	Microsoft ACPI-Compliant System
 (ISA) 0x0000006A (106)	Microsoft ACPI-Compliant System
 (ISA) 0x0000006B (107)	Microsoft ACPI-Compliant System
 (ISA) 0x0000006C (108)	Microsoft ACPI-Compliant System
 (ISA) 0x0000006D (109)	Microsoft ACPI-Compliant System
 (ISA) 0x0000006E (110)	Microsoft ACPI-Compliant System
 (ISA) 0x0000006F (111)	Microsoft ACPI-Compliant System
 (ISA) 0x00000070 (112)	Microsoft ACPI-Compliant System
 (ISA) 0x00000071 (113)	Microsoft ACPI-Compliant System
 (ISA) 0x00000072 (114)	Microsoft ACPI-Compliant System
 (ISA) 0x00000073 (115)	Microsoft ACPI-Compliant System
 (ISA) 0x00000074 (116)	Microsoft ACPI-Compliant System
(ISA) 0x00000075 (117)	Microsoft ACPI-Compliant System

	(ISA) 0x00000076 (118)	Microsoft ACPI-Compliant System
	(ISA) 0x00000077 (119)	Microsoft ACPI-Compliant System
	(ISA) 0x00000078 (120)	Microsoft ACPI-Compliant System
	(ISA) 0x00000079 (121)	Microsoft ACPI-Compliant System
	(ISA) 0x0000007A (122)	Microsoft ACPI-Compliant System
	(ISA) 0x0000007B (123)	Microsoft ACPI-Compliant System
	(ISA) 0x0000007C (124)	Microsoft ACPI-Compliant System
	(ISA) 0x0000007D (125)	Microsoft ACPI-Compliant System
	(ISA) 0x0000007E (126)	Microsoft ACPI-Compliant System
	(ISA) 0x0000007F (127)	Microsoft ACPI-Compliant System
	(ISA) 0x00000080 (128)	Microsoft ACPI-Compliant System
	(ISA) 0x00000081 (129)	Microsoft ACPI-Compliant System
	(ISA) 0x00000082 (130)	Microsoft ACPI-Compliant System
	(ISA) 0x00000083 (131)	Microsoft ACPI-Compliant System
	(ISA) 0x00000084 (132)	Microsoft ACPI-Compliant System
	(ISA) 0x00000085 (133)	Microsoft ACPI-Compliant System
	(ISA) 0x00000086 (134)	Microsoft ACPI-Compliant System
	(ISA) 0x00000087 (135)	Microsoft ACPI-Compliant System
	(ISA) 0x00000088 (136)	Microsoft ACPI-Compliant System
	(ISA) 0x00000089 (137)	Microsoft ACPI-Compliant System
	(ISA) 0x0000008A (138)	Microsoft ACPI-Compliant System
	(ISA) 0x0000008B (139)	Microsoft ACPI-Compliant System
	(ISA) 0x0000008C (140)	Microsoft ACPI-Compliant System
	(ISA) 0x0000008D (141)	Microsoft ACPI-Compliant System
	(ISA) 0x0000008E (142)	Microsoft ACPI-Compliant System
	(ISA) 0x0000008F (143)	Microsoft ACPI-Compliant System
	(ISA) 0x00000090 (144)	Microsoft ACPI-Compliant System
	(ISA) 0x00000091 (145)	Microsoft ACPI-Compliant System
	(ISA) 0x00000092 (146)	Microsoft ACPI-Compliant System
	(ISA) 0x00000093 (147)	Microsoft ACPI-Compliant System
	(ISA) 0x00000094 (148)	Microsoft ACPI-Compliant System
	(ISA) 0x00000095 (149)	Microsoft ACPI-Compliant System
	(ISA) 0x00000096 (150)	Microsoft ACPI-Compliant System
	(ISA) 0x00000097 (151)	Microsoft ACPI-Compliant System
	(ISA) 0x00000098 (152)	Microsoft ACPI-Compliant System
	(ISA) 0x00000099 (153)	Microsoft ACPI-Compliant System
	(ISA) 0x0000009A (154)	Microsoft ACPI-Compliant System
	(ISA) 0x0000009B (155)	Microsoft ACPI-Compliant System
	(ISA) 0x0000009C (156)	Microsoft ACPI-Compliant System
	(ISA) 0x0000009D (157)	Microsoft ACPI-Compliant System
	(ISA) 0x0000009E (158)	Microsoft ACPI-Compliant System
	(ISA) 0x0000009F (159)	Microsoft ACPI-Compliant System
	(ISA) 0x000000A0 (160)	Microsoft ACPI-Compliant System
	(ISA) 0x000000A1 (161)	Microsoft ACPI-Compliant System
	(ISA) 0x000000A2 (162)	Microsoft ACPI-Compliant System
	(ISA) 0x000000A3 (163)	Microsoft ACPI-Compliant System
	(ISA) 0x000000A4 (164)	Microsoft ACPI-Compliant System
	(ISA) 0x000000A5 (165)	Microsoft ACPI-Compliant System
	(ISA) 0x000000A6 (166)	Microsoft ACPI-Compliant System

	(ISA) 0x000000A7 (167)	Microsoft ACPI-Compliant System
	(ISA) 0x000000A8 (168)	Microsoft ACPI-Compliant System
	(ISA) 0x000000A9 (169)	Microsoft ACPI-Compliant System
	(ISA) 0x000000AA (170)	Microsoft ACPI-Compliant System
	(ISA) 0x000000AB (171)	Microsoft ACPI-Compliant System
	(ISA) 0x000000AC (172)	Microsoft ACPI-Compliant System
	(ISA) 0x000000AD (173)	Microsoft ACPI-Compliant System
	(ISA) 0x000000AE (174)	Microsoft ACPI-Compliant System
	(ISA) 0x000000AF (175)	Microsoft ACPI-Compliant System
	(ISA) 0x000000B0 (176)	Microsoft ACPI-Compliant System
	(ISA) 0x000000B1 (177)	Microsoft ACPI-Compliant System
	(ISA) 0x000000B2 (178)	Microsoft ACPI-Compliant System
	(ISA) 0x000000B3 (179)	Microsoft ACPI-Compliant System
	(ISA) 0x000000B4 (180)	Microsoft ACPI-Compliant System
	(ISA) 0x000000B5 (181)	Microsoft ACPI-Compliant System
	(ISA) 0x000000B6 (182)	Microsoft ACPI-Compliant System
	(ISA) 0x000000B7 (183)	Microsoft ACPI-Compliant System
	(ISA) 0x000000B8 (184)	Microsoft ACPI-Compliant System
	(ISA) 0x000000B9 (185)	Microsoft ACPI-Compliant System
	(ISA) 0x000000BA (186)	Microsoft ACPI-Compliant System
	(ISA) 0x000000BB (187)	Microsoft ACPI-Compliant System
	(ISA) 0x000000BC (188)	Microsoft ACPI-Compliant System
	(ISA) 0x000000BD (189)	Microsoft ACPI-Compliant System
	(ISA) 0x000000BE (190)	Microsoft ACPI-Compliant System
	(PCI) 0x00000005 (05)	Intel(R) Atom(TM)/Celeron(R)/Pentium(R) Processor Platform Control Unit - SMBus Port - 0F12
	(PCI) 0x00000010 (16)	Intel(R) Atom(TM)/Celeron(R)/Pentium(R) Processor PCI Express - Root Port 1 - 0F48
	(PCI) 0x00000011 (17)	Intel(R) Atom(TM)/Celeron(R)/Pentium(R) Processor PCI Express - Root Port 2 - 0F4A
	(PCI) 0x00000011 (17)	PCI standard PCI-to-PCI bridge
	(PCI) 0x00000011 (17)	PCI standard PCI-to-PCI bridge
	(PCI) 0x00000012 (18)	Intel(R) Atom(TM)/Celeron(R)/Pentium(R) Processor PCI Express - Root Port 3 - 0F4C
	(PCI) 0x00000012 (18)	PCI standard PCI-to-PCI bridge
	(PCI) 0x00000013 (19)	Intel(R) Atom(TM)/Celeron(R)/Pentium(R) Processor AHCI - 0F23
	(PCI) 0x00000013 (19)	Intel(R) Atom(TM)/Celeron(R)/Pentium(R) Processor PCI Express - Root Port 4 - 0F4E
	(PCI) 0x00000013 (19)	PCI standard PCI-to-PCI bridge
	(PCI) 0x00000013 (19)	PCI standard PCI-to-PCI bridge
	(PCI) 0xFFFFFFF1 (-15)	Intel(R) I211 Gigabit Network Connection
	(PCI) 0xFFFFFFF2 (-14)	Intel(R) I211 Gigabit Network Connection
	(PCI) 0xFFFFFFF3 (-13)	Intel(R) I211 Gigabit Network Connection
	(PCI) 0xFFFFFFF4 (-12)	Intel(R) I211 Gigabit Network Connection
	(PCI) 0xFFFFFFF5 (-11)	Intel(R) I211 Gigabit Network Connection
	(PCI) 0xFFFFFFF6 (-10)	Intel(R) I211 Gigabit Network Connection
	(PCI) 0xFFFFFFF7 (-9)	Intel(R) I211 Gigabit Network Connection #2
	(PCI) 0xFFFFFFF8 (-8)	Intel(R) I211 Gigabit Network Connection #2
	(PCI) 0xFFFFFFF9 (-7)	Intel(R) I211 Gigabit Network Connection #2
	(PCI) 0xFFFFFFFA (-6)	Intel(R) I211 Gigabit Network Connection #2
	(PCI) 0xFFFFFFFB (-5)	Intel(R) I211 Gigabit Network Connection #2
	(PCI) 0xFFFFFFFC (-4)	Intel(R) I211 Gigabit Network Connection #2
	(PCI) 0xFFFFFFFDD (-3)	Intel(R) USB 3.0 eXtensible Host Controller
	(PCI) 0xFFFFFFFEE (-2)	Intel(R) HD Graphics